

Oracle® OLAP

Developer's Guide to the OLAP API

10g Release 2 (10.2)

B14347-01

June 2005

Oracle OLAP Developer's Guide to the OLAP API, 10g Release 2 (10.2)

B14347-01

Copyright © 2000, 2005 Oracle. All rights reserved.

Primary Author: David McDermid

The Programs (which include both the software and documentation) contain proprietary information; they are provided under a license agreement containing restrictions on use and disclosure and are also protected by copyright, patent, and other intellectual and industrial property laws. Reverse engineering, disassembly, or decompilation of the Programs, except to the extent required to obtain interoperability with other independently created software or as specified by law, is prohibited.

The information contained in this document is subject to change without notice. If you find any problems in the documentation, please report them to us in writing. This document is not warranted to be error-free. Except as may be expressly permitted in your license agreement for these Programs, no part of these Programs may be reproduced or transmitted in any form or by any means, electronic or mechanical, for any purpose.

If the Programs are delivered to the United States Government or anyone licensing or using the Programs on behalf of the United States Government, the following notice is applicable:

U.S. GOVERNMENT RIGHTS Programs, software, databases, and related documentation and technical data delivered to U.S. Government customers are "commercial computer software" or "commercial technical data" pursuant to the applicable Federal Acquisition Regulation and agency-specific supplemental regulations. As such, use, duplication, disclosure, modification, and adaptation of the Programs, including documentation and technical data, shall be subject to the licensing restrictions set forth in the applicable Oracle license agreement, and, to the extent applicable, the additional rights set forth in FAR 52.227-19, Commercial Computer Software—Restricted Rights (June 1987). Oracle Corporation, 500 Oracle Parkway, Redwood City, CA 94065

The Programs are not intended for use in any nuclear, aviation, mass transit, medical, or other inherently dangerous applications. It shall be the licensee's responsibility to take all appropriate fail-safe, backup, redundancy and other measures to ensure the safe use of such applications if the Programs are used for such purposes, and we disclaim liability for any damages caused by such use of the Programs.

Oracle, JD Edwards, PeopleSoft, and Retek are registered trademarks of Oracle Corporation and/or its affiliates. Other names may be trademarks of their respective owners.

The Programs may provide links to Web sites and access to content, products, and services from third parties. Oracle is not responsible for the availability of, or any content provided on, third-party Web sites. You bear all risks associated with the use of such content. If you choose to purchase any products or services from a third party, the relationship is directly between you and the third party. Oracle is not responsible for: (a) the quality of third-party products or services; or (b) fulfilling any of the terms of the agreement with the third party, including delivery of products or services and warranty obligations related to purchased products or services. Oracle is not responsible for any loss or damage of any sort that you may incur from dealing with any third party.

Contents

Preface	xi
Audience	xi
Documentation Accessibility	xi
Related Documents	xii
Conventions	xii
What's New	xiii
Introducing Custom Dimension Members	xiii
Introducing the OLAP API Model	xiii
Introducing DataProvider Language Specification and Other Properties	xiv
New OLAP API Classes	xv
New Methods of Existing Classes	xvi
New and Revised Example Programs	xvii
1 Introduction to the OLAP API	
OLAP API Overview	1-1
Multidimensional Concepts and the OLAP API	1-1
What Type of Data Can an Application Access Through the OLAP API?	1-2
What Can an Application Do with the OLAP API?	1-3
Context for OLAP API Development	1-3
Sample Schema for OLAP API Examples	1-3
Access to Data and Metadata Through the OLAP API	1-4
MDM Model in the OLAP API	1-5
Access to Data Through the OLAP API	1-5
Unique and Local Dimension Values	1-6
User Connection Requirements	1-7
OLAP API Client Software	1-7
Requirements for Using the OLAP API Client Software	1-7
Tasks That an OLAP API Application Performs	1-7
Task 1: Connect to the Data Store	1-8
Task 2: Discover the Available Metadata	1-8
Task 3: Select and Calculate Data Through Queries	1-8
Task 4: Retrieve Query Results	1-9

2 Understanding OLAP API Metadata

Overview of the OLAP API Metadata	2-1
Data Preparation	2-1
Metadata Preparation	2-2
OLAP Metadata Objects	2-2
Dimensions in the OLAP Metadata.....	2-2
Measures in the OLAP Metadata.....	2-3
Measure Folders in the OLAP Metadata	2-3
Overview of MDM Metadata Objects in the OLAP API	2-3
Mapping of OLAP Metadata Objects to MDM objects.....	2-4
MdmModel Class	2-5
MdmSchema Class.....	2-5
MdmSource Class.....	2-6
MdmDimension Classes	2-6
MdmPrimaryDimension Classes	2-7
MdmSubDimension Classes.....	2-7
MdmHierarchy.....	2-7
MdmLevelHierarchy	2-8
MdmValueHierarchy	2-8
MdmLevel.....	2-8
MdmDimensionedObject Classes	2-9
MdmMeasure.....	2-9
MdmAttribute Class	2-10
MdmMember Classes	2-11
Data Type and Type of MDM Metadata Objects	2-13
Data Type of MDM Metadata Objects	2-14
Getting the Data Type of an MdmSource.....	2-15
Type of MDM Metadata Objects.....	2-16
Getting the Type of an MdmSource	2-17
Creating Custom Metadata Objects	2-17

3 Connecting to a Data Store

Overview of the Connection Process	3-1
Connection Steps.....	3-1
Prerequisites for Connecting	3-1
Establishing a Connection	3-2
Step 1: Load the JDBC Driver	3-2
Step 2: Get a Connection from the DriverManager.....	3-2
Step 3: Create a TransactionProvider	3-3
Step 4: Create a DataProvider	3-3
Getting an Existing Connection	3-3
Executing DML Commands Through the Connection	3-4
Closing a Connection	3-4

4	Discovering the Available Metadata	
	Overview of the Procedure for Discovering Metadata	4-1
	MDM Metadata	4-1
	Purpose of Discovering the Metadata	4-2
	Steps in Discovering the Metadata	4-2
	Discovering Metadata and Making Queries	4-2
	Creating an MdmMetadataProvider	4-2
	Getting the Root MdmSchema	4-3
	Function of the Root MdmSchema	4-3
	Calling the getRootSchema Method	4-4
	Getting the Contents of the Root MdmSchema	4-4
	Getting the MdmDimension Objects in an MdmSchema	4-5
	Getting the Subschemas in an MdmSchema	4-5
	Getting the Contents of Subschemas	4-5
	Getting the MdmMeasureDimension and Its Contents	4-5
	Getting the Characteristics of Metadata Objects	4-5
	Getting the MdmDimension Objects for an MdmMeasure	4-5
	Getting the Related Objects for an MdmPrimaryDimension	4-6
	Getting the Source for a Metadata Object	4-6
	Sample Code for Discovering Metadata	4-7
	Code for the SampleMetadataDiscoverer10g Program	4-7
	Output from the SampleMetadataDiscoverer10g Program	4-13
5	Working with Metadata Mapping Objects	
	Overview of the MTM Classes	5-1
	SELECT Statements for MdmSource Objects	5-2
	Purpose of MTM Objects	5-2
	Measures, Cubes, and Hierarchies	5-3
	Discovering the Columns Mapped To an MdmSource	5-3
	Example of Getting the Columns Mapped To an MdmLevelHierarchy	5-4
	Example of Getting the Columns Mapped To an MdmLevel	5-4
	Example of Getting the Columns Mapped To an MdmMeasure	5-5
	Creating a Custom Measure	5-5
	Understanding Solved and Unsolved Data	5-6
	Solved Versus Unsolved Cubes and Hierarchies	5-6
	Aggregation Forms for Cubes	5-7
	Aggregation for Unsolved Cubes	5-7
	Aggregation for Solved Cubes	5-8
	Solve Specifications for Unsolved Cubes	5-9
6	Understanding Source Objects	
	Overview of Source Objects	6-1
	Kinds of Source Objects	6-2

Characteristics of Source Objects	6-3
Data Type of a Source.....	6-3
Type of a Source	6-4
Source Identification and SourceDefinition of a Source.....	6-5
Inputs and Outputs of a Source	6-6
Inputs of a Source.....	6-6
Outputs of a Source.....	6-7
Matching a Source To an Input	6-10
Describing Parameterized Source Objects	6-15
Model Objects and Source Objects	6-17
Describing the Model for a Source	6-17
Creating a CustomModel - Example	6-19
Dependent Assignment Values - Example.....	6-20
A Custom Member That Specifies an Aggregated Value - Example.....	6-22

7 Making Queries Using Source Methods

Describing the Basic Source Methods	7-1
Using the Basic Methods	7-2
Using the alias Method.....	7-2
Using the distinct Method	7-3
Using the join Method	7-5
Using the position Method	7-7
Using the recursiveJoin Method	7-8
Using the value Method.....	7-10
Using Other Source Methods	7-11
Using the extract Method.....	7-11
Creating a Cube and Pivoting Edges	7-12
Drilling Up and Down in a Hierarchy	7-16
Sorting Hierarchically by Measure Values.....	7-17
Using NumberSource Methods To Compute the Share of Units Sold.....	7-19
Ranking Dimension Elements by Measure Value	7-20
Selecting Based on Time Series Operations.....	7-22
Selecting a Set of Elements Using Parameterized Source Objects	7-24

8 Using a TransactionProvider

About Creating a Query in a Transaction	8-1
Types of Transaction Objects.....	8-2
Preparing and Committing a Transaction.....	8-2
About Transaction and Template Objects	8-3
Beginning a Child Transaction.....	8-3
About Rolling Back a Transaction	8-5
Getting and Setting the Current Transaction.....	8-7
Using TransactionProvider Objects	8-7

9 Understanding Cursor Classes and Concepts

Overview of the OLAP API Cursor Objects	9-1
Creating a Cursor Using a CursorManagerSpecification	9-2
Creating a Cursor Without a CursorManagerSpecification	9-3
Sources For Which You Cannot Create a Cursor	9-3
Cursor Objects and Transaction Objects	9-3
Cursor Classes	9-4
Structure of a Cursor	9-4
Specifying the Behavior of a Cursor	9-6
CursorManagerSpecification Class	9-6
CursorInfoSpecification Classes	9-7
CursorManager Classes	9-8
Updating the CursorManagerSpecification for a CursorManager	9-9
Other Classes	9-9
CursorInput Class	9-10
CursorManagerUpdateListener Class	9-10
CursorManagerUpdateEvent Class	9-10
About Cursor Positions and Extent	9-11
Positions of a ValueCursor	9-11
Positions of a CompoundCursor	9-12
About the Parent Starting and Ending Positions in a Cursor	9-15
What is the Extent of a Cursor?	9-17
About Fetch Sizes	9-18

10 Retrieving Query Results

Retrieving the Results of a Query	10-1
Getting Values from a Cursor	10-2
Navigating a CompoundCursor for Different Displays of Data	10-7
Specifying the Behavior of a Cursor	10-14
Calculating Extent and Starting and Ending Positions of a Value	10-15
Specifying a Fetch Size	10-18

11 Creating Dynamic Queries

About Template Objects	11-1
About Creating a Dynamic Source	11-1
About Translating User Interface Elements into OLAP API Objects	11-2
Overview of Template and Related Classes	11-2
What Is the Relationship Between the Classes That Produce a Dynamic Source?	11-3
Template Class	11-3
MetadataState Interface	11-3
SourceGenerator Interface	11-3
DynamicDefinition Class	11-4
Designing and Implementing a Template	11-4
Implementing the Classes for a Template	11-5
Implementing an Application That Uses Templates	11-9

A Setting Up the Development Environment

Overview A-1
Required Class Libraries..... A-1
Obtaining the Class Libraries A-1

B SingleSelectionTemplate Class

Code for the SingleSelectionTemplate Class B-1

Index

List of Examples

2-1	Creating a Custom Member of a Dimension	2-13
2-2	Getting the Data Type of an MdmSource.....	2-16
2-3	Getting the Type of an MdmSource	2-17
2-4	Creating a Custom Member of the MdmMeasureDimension.....	2-18
3-1	Loading the JDBC Driver for a Connection	3-2
3-2	Getting a JDBC OracleConnection.....	3-2
3-3	Creating a TransactionProvider.....	3-3
3-4	Creating a DataProvider	3-3
3-5	Getting an Existing Connection	3-3
3-6	Executing DML Commands.....	3-4
3-7	Closing a Connection.....	3-4
4-1	Creating an MdmMetadataProvider.....	4-3
4-2	Getting the Root MdmSchema.....	4-4
4-3	Getting MdmDimension Objects	4-5
4-4	Getting Subschemas.....	4-5
4-5	Getting the MdmMeasureDimension and Its Contents	4-5
4-6	Getting the Dimensions of an MdmMeasure.....	4-6
4-7	Getting the MdmHierarchy Components of an MdmPrimaryDimension.....	4-6
4-8	Getting a Primary Source for a Metadata Object.....	4-7
4-9	Discovering the OLAP Catalog Metadata	4-7
5-1	Getting the Columns for an MtmLevelHierarchyMap.....	5-4
5-2	Getting the Column Mapped To an MdmLevel.....	5-4
5-3	Getting the Columns For an MdmMeasure	5-5
5-4	Creating a Custom Measure.....	5-6
6-1	Getting the Data Type of a Source.....	6-4
6-2	Using the isSubtypeOf Method.....	6-5
6-3	Using the join Method To Produce a Source Without an Output	6-8
6-4	Using the join Method To Produce a Source With an Output	6-8
6-5	Using the join Method To Match Source Objects To Inputs.....	6-9
6-6	Using Shortcuts	6-10
6-7	Matching the Base Source to an Input of the Joined Source	6-11
6-8	Matching an Input of the Base Source to an Output of the Joined Source	6-12
6-9	Matching the Inputs of a Measure and Producing Outputs.....	6-14
6-10	Using a Parameterized Source With a Measure Dimension.....	6-16
6-11	Implementing the extract method as a CustomModel.....	6-19
6-12	Creating an Assignment That Depends on Another Assignment	6-21
6-13	Creating a Custom Member That Assigns an Aggregated Value.....	6-22
7-1	Controlling Input-to-Source Matching With the alias Method	7-3
7-2	Using the distinct Method	7-4
7-3	Using COMPARISON_RULE_REMOVE	7-5
7-4	Using COMPARISON_RULE_DESCENDING	7-6
7-5	Selecting the First and Last Time Elements	7-7
7-6	Sorting Products Hierarchically By Color	7-9
7-7	Selecting a Subset of the Elements of a Source	7-10
7-8	Using the extract Method	7-12
7-9	Creating a Cube and Pivoting Its Edges.....	7-13
7-10	Drilling in a Hierarchy	7-16
7-11	Hierarchical Sorting by Measure Value.....	7-18
7-12	Getting the Share of Units Sold.....	7-20
7-13	Ranking Products by Units Sold.....	7-21
7-14	Using the Lag Method.....	7-22
7-15	Using the movingTotal Method.....	7-23
7-16	Selecting a Range With NumberParameter Objects	7-24

8-1	Rolling Back a Transaction	8-5
8-2	Using Child Transaction Objects	8-8
9-1	Creating the querySource Query	9-4
9-2	Setting the CompoundCursor Position and Getting the Current Values	9-13
9-3	Positions in an Asymmetric Query	9-14
10-1	Creating a Cursor	10-2
10-2	Getting a Single Value from a ValueCursor	10-3
10-3	Getting All of the Values from a ValueCursor	10-4
10-4	Getting ValueCursor Objects from a CompoundCursor	10-4
10-5	Getting Values from a CompoundCursor with Nested Outputs	10-5
10-6	Navigating for a Table View	10-7
10-7	Navigating for a Crosstab View without Pages	10-9
10-8	Navigating for a Crosstab View with Pages	10-11
10-9	Getting CursorSpecification Objects from a CursorManagerSpecification	10-14
10-10	Specifying the Calculation of the Extent of a Cursor	10-15
10-11	Specifying the Calculation of Starting and Ending Positions in a Parent	10-16
10-12	Calculating the Span of the Positions in the Parent of a Value	10-16
10-13	Specifying a Fetch Size	10-18
11-1	Implementing a Template	11-5
11-2	Implementing a MetadataState	11-8
11-3	Implementing a SourceGenerator	11-8
11-4	Getting the Source Produced by the Template	11-10

Preface

Oracle OLAP Developer's Guide to the OLAP API introduces Java programmers to the Oracle OLAP API, which is the Java application programming interface for Oracle OLAP. Through Oracle OLAP, the OLAP API provides access to data stored in an Oracle database. The OLAP API capabilities for querying, manipulating, and presenting data are particularly suited to applications that perform online analytical processing (OLAP) operations.

The preface contains these topics:

- [Audience](#)
- [Documentation Accessibility](#)
- [Related Documents](#)
- [Conventions](#)

Audience

Oracle OLAP Developer's Guide to the OLAP API is intended for Java programmers who are responsible for creating applications that perform analysis using Oracle OLAP. To use this manual, you should be familiar with Java, relational database management systems, data warehousing, OLAP concepts, and Oracle OLAP.

Documentation Accessibility

Our goal is to make Oracle products, services, and supporting documentation accessible, with good usability, to the disabled community. To that end, our documentation includes features that make information available to users of assistive technology. This documentation is available in HTML format, and contains markup to facilitate access by the disabled community. Accessibility standards will continue to evolve over time, and Oracle is actively engaged with other market-leading technology vendors to address technical obstacles so that our documentation can be accessible to all of our customers. For more information, visit the Oracle Accessibility Program Web site at

<http://www.oracle.com/accessibility/>

Accessibility of Code Examples in Documentation

Screen readers may not always correctly read the code examples in this document. The conventions for writing code require that closing braces should appear on an otherwise empty line; however, some screen readers may not always read a line of text that consists solely of a bracket or brace.

Accessibility of Links to External Web Sites in Documentation

This documentation may contain links to Web sites of other companies or organizations that Oracle does not own or control. Oracle neither evaluates nor makes any representations regarding the accessibility of these Web sites.

TTY Access to Oracle Support Services

Oracle provides dedicated Text Telephone (TTY) access to Oracle Support Services within the United States of America 24 hours a day, seven days a week. For TTY support, call 800.446.2398.

Related Documents

For more information, see these Oracle resources:

- *Oracle OLAP Java API Reference*
- *Oracle OLAP Application Developer's Guide*
- *Oracle OLAP Analytic Workspace Java API Reference*
- *Oracle OLAP Reference*
- *Oracle OLAP DML Reference*
- *Oracle Database JDBC Developer's Guide and Reference*
- *Oracle Database Data Warehousing Guide*

Conventions

The following text conventions are used in this document:

Convention	Meaning
boldface	Boldface type indicates graphical user interface elements associated with an action, or terms defined in text or the glossary.
<i>italic</i>	Italic type indicates book titles, emphasis, or placeholder variables for which you supply particular values.
monospace	Monospace type indicates commands within a paragraph, URLs, code in examples, text that appears on the screen, or text that you enter.

What's New

This preface describes the features of the Oracle OLAP API that are new in Oracle OLAP 10g Release 2 (10.2). This preface contains the following topics:

- [Introducing Custom Dimension Members](#)
- [Introducing the OLAP API Model](#)
- [Introducing DataProvider Language Specification and Other Properties](#)
- [New OLAP API Classes](#)
- [New Methods of Existing Classes](#)
- [New and Revised Example Programs](#)

Introducing Custom Dimension Members

The Oracle OLAP API now supports the creation of custom dimension members, which are calculated virtual members that you can use in specifying a query. When you create a custom dimension member, you provide a `Source` that Oracle OLAP uses to calculate the value for a dimensioned object that is specified by the custom member. When you specify a query that retrieves the value of a dimensioned object that is specified by the custom member, Oracle OLAP calculates the value for the custom member and assigns it as the value of the dimensioned object.

Custom dimension members are instances of the classes that implement the new `MdmMember` interface. You can create a custom member for an `MdmStandardDimension`, an `MdmTimeDimension`, or an `MdmMeasureDimension`. For more information on custom dimension members and for examples of creating them, see [Chapter 2, "Understanding OLAP API Metadata"](#).

Oracle OLAP uses an `MdmModel` to hold information for a custom dimension member. An `MdmModel` implements the `Model` interface. When you create a custom dimension member, Oracle OLAP automatically creates an `Assignment` object and adds it to the `MdmModel` associated with the dimension. The `Assignment` object specifies the dimension, the dimension member, and the `Source` that Oracle OLAP uses to calculate the value to assign for the dimension member. For information about the `Model` interface and the `Assignment` class, see ["Introducing the OLAP API Model"](#).

Introducing the OLAP API Model

A `Source` that has inputs is a **dimensioned** `Source`. With an `OLAP API Model`, you can assign calculated values to a dimensioned `Source`. Using `Model` objects, you can specify elements of the inputs and specify the calculation that produces the value to assign to the dimensioned `Source`.

The `MdmModel` class and its subclasses implement the `Model` interface for `MdmObject` objects. Those classes are in the `oracle.olapi.metadata.mdm` package.

The `CustomModel` class implements the interface for an object that you can explicitly create and that is not necessarily associated with an `MdmObject`. In creating a `CustomModel`, you specify its input `Source` objects.

A `Model` is closely related to a `Source`, so the `Model` interface, the associated `Assignment` and `Qualification` classes, and the `CustomModel` class are in the `oracle.olapi.data.source` package. A `Qualification` identifies an element of a `Source`. For example, a `Qualification` might specify a member of a dimension. An `Assignment` has one or more `Qualification` objects and a `Source` that Oracle OLAP uses to calculate the value to assign. A `Model` can have from zero to many `Assignment` objects.

When Oracle OLAP retrieves the values for a dimensioned `Source`, it evaluates the `Assignment` objects of the `Model` associated with the `Source`. It assigns the results of the calculations specified by the `Assignment` objects to the elements of the dimensioned `Source` that are specified by the `Qualification` objects of the `Assignment` objects.

Because the calculations specified by the `Assignment` objects of a `Model` can apply to any `Source` that has the same inputs as the `Model`, the OLAP API requires a way to represent the `Source` to which Oracle OLAP is currently applying the `Model`. The role of representing the current dimensioned `Source` is taken by a placeholder `Source`, which is a new type of `Source`.

The OLAP API has placeholder `Source` objects for the different data types. You get a placeholder `Source` by first getting a `FundamentalMetadataObject` object for a placeholder of a specific data type from your `FundamentalMetadataProvider`. You then call the `getSource` method of the `FundamentalMetadataObject`.

For examples of using placeholder `Source` objects and a `CustomModel`, see "[New and Revised Example Programs](#)". For more information on the `Model` classes, see [Chapter 6, "Understanding Source Objects"](#).

Introducing DataProvider Language Specification and Other Properties

The `ExpressDataProvider` class now has constructors that take a `java.util.Locale` object, a `java.util.Properties` object, or both. By passing a `Locale` object to the constructor, you can create an `ExpressDataProvider` that can provide string values in the language specified for an analytic workspace that supports the language.

An `ExpressDataProvider` has certain default characteristics or properties, which include the following.

- It uses unique dimension hierarchy member values.
- It recognizes both OLAP Catalog metadata and standard form analytic workspace metadata.
- For an analytic workspace, it issues an `ALTER SESSION SET NLS_LANGUAGE SQL` command that sets the language of the database.

By passing a `Properties` object to the constructor, you can create an `ExpressDataProvider` that has different properties. You can specify that the `ExpressDataProvider` use local dimension member values. For information on local and unique dimension member values, see "[Unique and Local Dimension Values](#)" in [Chapter 1, "Introduction to the OLAP API"](#).

You can also create an `ExpressDataProvider` that has an associated `MetadataProvider` that recognizes only OLAP Catalog metadata, which is generated by Oracle Enterprise Manager and by PL/SQL CWM2 package APIs, or only standard form analytic workspace metadata, which is generated by Analytic Workspace Manager and by the Oracle OLAP Analytic Workspace Java API, or only the custom metadata objects you create by using classes in the `oracle.olapi.metadata.mdm` and `oracle.olapi.metadata.mtm` packages.

If you want your application to control the language properties, then you can specify that the `ExpressDataProvider` does not use the default language. For more information on setting the properties of an `ExpressDataProvider`, see the description of that class in the *Oracle OLAP Java API Reference*.

New OLAP API Classes

This section describes the new classes in the OLAP API.

New Classes in the `oracle.olap.data.source` Package

The following table lists the new classes in the `oracle.olapi.data.source` package and provides brief descriptions of them.

Class	Description
<code>Model</code>	An interface for an object that contains <code>Assignment</code> objects. This interface is implemented by the <code>MdmModel</code> and <code>CustomModel</code> classes.
<code>CustomModel</code>	A <code>Model</code> that an application can explicitly create.
<code>Assignment</code>	A class that contains one or more <code>Qualification</code> objects and a <code>Source</code> that Oracle OLAP uses to calculate a value to assign.
<code>Qualification</code>	An abstract class that represents an element of a <code>Source</code> for an <code>Assignment</code> of a <code>Model</code> . A <code>Qualification</code> identifies the element of an input <code>Source</code> to which the <code>Assignment</code> applies.
<code>LiteralQualification</code>	A concrete class that extends <code>Qualification</code> and that represents a literal value that identifies an element of an input <code>Source</code> , such as a member of a dimension.
<code>ModelSolutionDefinition</code>	A <code>SourceDefinition</code> that has information about solving a <code>CustomModel</code> .
<code>PlaceholderDefinition</code>	A <code>SourceDefinition</code> for a placeholder <code>Source</code> .

For more information on these new classes, see [Chapter 6, "Understanding Source Objects"](#).

New Classes in the `oracle.olap.metadata.mdm` Package

The following table lists the new classes in the `oracle.olapi.metadata.mdm` package and provides brief descriptions of them.

Class	Description
<code>MdmModel</code>	An abstract class that implements the <code>Model</code> interface for <code>MdmObject</code> objects.

Class	Description
<code>MdmDimensionCalculationModel</code>	An <code>MdmModel</code> of a specific data type for an <code>MdmPrimaryDimension</code> .
<code>MdmDimensionedObjectModel</code>	An abstract class that extends <code>MdmModel</code> for dimensioned objects.
<code>MdmAttributeModel</code>	An <code>MdmDimensionedObjectModel</code> for <code>MdmAttribute</code> objects.
<code>MdmMeasureModel</code>	An <code>MdmDimensionedObjectModel</code> for <code>MdmMeasure</code> objects.
<code>MdmMember</code>	An interface for a custom dimension member.
<code>MdmStandardMember</code>	An implementation of <code>MdmMember</code> for an <code>MdmStandardDimension</code> .
<code>MdmTimeMember</code>	An implementation of <code>MdmMember</code> for an <code>MdmTimeDimension</code> .

The `MdmMeasure` class now implements the `MdmMember` interface for members of an `MdmMeasureDimension`.

For more information on these new classes, see [Chapter 2, "Understanding OLAP API Metadata"](#).

New Methods of Existing Classes

The following classes in the `oracle.olapi.data.source` package have new factory or accessor methods related to an OLAP API Model or to custom dimension members.

- `ConstantListDefinition`
- `DataProvider`
- `FundamentalMetadataProvider`
- `Source`
- `SourceDefinition`

The following classes in the `oracle.olapi.metadata.mdm` package have new factory, accessor, or other methods related to an OLAP API Model or to custom dimension members.

- `Mdm10_1_0_3_NamingConvention`
- `Mdm10_1_0_3_ObjectVisitor`
- `MdmCustomObjectFactory`
- `MdmMeasure`
- `MdmMeasureDimension`
- `MdmPrimaryDimension`
- `MdmSource`
- `MdmStandardDimension`
- `MdmTimeDimension`

The `oracle.express.olapi.data.full.ExpressDataProvider` class has new constructor methods that accept `java.util.Locale` or `java.util.Properties` objects or both. It also has new methods that accept a `Properties` object and that create one or more `CursorManager`

New and Revised Example Programs

This release of the Oracle OLAP API includes new example programs that demonstrate the use of `Model` objects, custom dimension members, and placeholder `Source` objects. Some previously existing example programs have significant revisions.

The example programs contain the complete code for the examples that appear in this document. They are available from the Overview of the *Oracle OLAP Java API Reference*.

New Example Programs

The new example programs and the examples for which they contain the complete code are the following:

- `CreateCustomDimensionMember.java`, [Example 2-1](#), "Creating a Custom Member of a Dimension".
- `CreateCustomMeasureDimensionMember.java`, [Example 2-4](#), "Creating a Custom Member of the `MdmMeasureDimension`".
- `ImplementingExtractAsACustomModel.java`, [Example 6-11](#), "Implementing the `extract` method as a `CustomModel`".
- `CreateDependentAssignment.java`, [Example 6-12](#), "Creating an Assignment That Depends on Another Assignment".
- `CreateCustomMemberWithAggVal.java`, [Example 6-13](#), "Creating a Custom Member That Assigns an Aggregated Value".
- `CreateColorAttribute.java`, which is a class that creates a custom color `MdmAttribute` that is used by the `CreateCustomMemberWithAggVal.java` class.

Revised Example Programs

The example programs that have significant revisions are the following:

- `TransactionExamples.java`, [Example 8-1](#), "Rolling Back a Transaction" and [Example 8-2](#), "Using Child Transaction Objects".
- `TopBottomTest.java`, [Example 11-4](#), "Getting the Source Produced by the Template".
- `SingleSelectionTemplate.java`, [Appendix B](#), "SingleSelectionTemplate Class".

The complete code for the `TopBottomTest.java` and `SingleSelectionTemplate.java` classes are in this document as well as being in the *Oracle OLAP Java API Reference*.

Introduction to the OLAP API

This chapter introduces the Oracle OLAP API to application developers who plan to use it in their Java applications.

This chapter includes the following topics:

- [OLAP API Overview](#)
- [Sample Schema for OLAP API Examples](#)
- [Access to Data and Metadata Through the OLAP API](#)
- [OLAP API Client Software](#)
- [Tasks That an OLAP API Application Performs](#)

OLAP API Overview

The OLAP API is a Java application programming interface (API) through which an application can access data for online analytical processing (OLAP). The Java classes that implement the API are part of the Oracle OLAP component.

The purpose of the OLAP API is to facilitate the development of OLAP applications, which allow users to dynamically select, aggregate, calculate, and perform other analytical tasks on data through a graphical user interface. Typically, the user interface of an OLAP application displays data in multidimensional formats, such as graphs and crosstabs.

In general, OLAP applications are developed within the context of business intelligence and data warehousing systems, and the features of the OLAP API are optimized for this type of application. With the OLAP API, a Java application can access, manipulate, and display data in multidimensional terms. The OLAP API also makes it possible to define a query in a step-by-step process that allows for undoing individual query steps without reproducing the entire query. Such multistep queries are easy to modify and refine dynamically.

Multidimensional Concepts and the OLAP API

Data warehousing and OLAP applications are based on a multidimensional view of data, and they work with queries that represent selections of data. The following definitions introduce concepts that reflect the multidimensional view and are basic to data warehousing, OLAP, and the OLAP API:

- **Dimension.** A structure that categorizes data. Commonly-used dimensions are customers, products, and times. Typically, the members of a dimension are organized one or more hierarchies that have one or more levels. Sets of members of different dimensions identify measure values. By specifying dimension

members, measures, and calculations to perform on the data, end users formulate business questions and get answers to their queries. For example, using a time dimension that categorizes data by month, a product dimension that categorizes data by item, and a measure that contains data for the unit cost of product items by month, an application can formulate the query, "Did we sell more widgets in January or June?"

- **Measure.** Data, usually numeric and additive, that can be examined and analyzed. Typically, a measure is categorized by one or more dimensions, and it is described as "dimensioned by" them.
- **Hierarchy.** A logical structure that uses ordered levels or values as a means of organizing dimension members in parent-child relationships. Typically, end users can expand or collapse the hierarchy by drilling down or up on its levels.
- **Level.** A position in a level-based hierarchy. For example, a time dimension might have a hierarchy that has members that represents data at the day, month, quarter, and year levels.
- **Attribute.** A descriptive characteristic of the members of a dimension that an end user can specify to select data. For example, end users might choose products using a color attribute.
- **Query.** A specification for a particular set of data, and for aggregations, calculations, or other operations to perform using the data. Any such operations on the data are an intrinsic part of the query. The data and the operations on it define the result set of the query.

Two additional data warehouse and OLAP concepts, cube and edge, are not intrinsic to the OLAP API, but are often incorporated into the design of applications that use the OLAP API.

- **Cube.** A logical organization of multidimensional data. Typically, the edges of a cube contain dimension member values, and the body of a cube contains measure values. For example, data on the quantity of product units sold can be organized into a cube whose edges contain values for members from the time, product, customer, and channel dimensions and whose body contains values from the units sold measure.
- **Edge.** One side of a cube. Each edge contains values of members from one or more dimensions. Although there is no limit to the number of edges on a cube, data is often organized for display purposes along three edges, which are referred to as the row edge, column edge, and page edge.

For more information about all of these concepts, see the *Oracle Database Data Warehousing Guide*.

What Type of Data Can an Application Access Through the OLAP API?

The OLAP API, as part of Oracle OLAP, makes it possible for Java applications (including applets) to access data that resides in an Oracle data warehouse. A data warehouse is a relational database that is designed for query and analysis, rather than transaction processing. Warehouse data often conforms to a star schema, which represents a multidimensional data model. The star schema consists of one or more fact tables and one or more dimension tables that are related through foreign keys. Typically, a data warehouse is created from a transaction processing database by an extraction transformation transport (ETT) tool, such as Oracle Warehouse Builder.

In order for the OLAP API to access the data in a given data warehouse, a database administrator must first ensure that the data warehouse is configured according to an

organization that is supported by Oracle OLAP. The star schema is one such organization, but not the only one. Once the data is organized in the warehouse, the database administrator must map the data to OLAP metadata objects and add them to the OLAP Catalog or create a dynamic analytic workspace based on the data. Finally, with the metadata in place, an application can access both the data and the metadata through the OLAP API.

See the *Oracle OLAP Application Developer's Guide* for information about supported data warehouse configurations and about creating OLAP Catalog metadata or a dynamic analytic workspace.

The collection of warehouse data for which a database administrator has mapped OLAP Catalog elements or created a dynamic analytic workspace is the data store to which the OLAP API gives access. Of course, each user who accesses data through the OLAP API might have security restrictions that limit the scope of the data that he or she can access within the data store.

With the factory classes in the `oracle.olapi.metadata.mdm` and `oracle.olapi.metadata.mtm` packages, an application developer can create transient custom metadata objects. For more information, see [Chapter 2, "Understanding OLAP API Metadata"](#) and [Chapter 5, "Working with Metadata Mapping Objects"](#).

What Can an Application Do with the OLAP API?

Through the OLAP API, an application can do the following:

- Establish a connection to a data store.
- Explore the metadata to discover what data is available for viewing or analysis.
- Create queries that specify and manipulate the data according to the needs of application users (for example, selecting, aggregating, and calculating data).
- Retrieve query results that are structured for display in multidimensional format.
- Modify existing queries, rather than totally redefine them, as application users refine their analyses.

Context for OLAP API Development

The OLAP API is a Java API, so it has all of the advantages of the Java environment. It is platform independent, and it provides the benefits of an object-oriented API, such as abstraction, encapsulation, polymorphism, and inheritance. These strengths are built into the OLAP API, and because the client application is written in Java, its code can also take advantage of them.

In order to work with the OLAP API, application developers should have familiarity with Java, object-oriented programming, relational databases, data warehousing, and multidimensional OLAP concepts.

Sample Schema for OLAP API Examples

This documentation has examples of OLAP API code that use a relational schema, named the Global Schema for Documentation with OLAP Catalog Metadata. For the complete code of the examples in this documentation and for information on how to download the SQL scripts that create the schema, see the *Overview of the Oracle OLAP Java API Reference*.

The OLAP Catalog for the Global Schema for Documentation with OLAP Catalog Metadata has the following measures:

- `UNITS`, which has the quantities of product units sold.
- `UNIT_COST`, which has the cost of a unit.
- `UNIT_PRICE`, which has the price of a unit.

The data in the measures is identified by detailed (leaf-level) data or aggregate (node-level) data from dimensions. The `UNITS` measure is dimensioned by the following dimensions:

- `PRODUCT`, which has a hierarchy of product values named `PRODUCT_ROLLUP`. The leaf level of the hierarchy has product item identification numbers and the higher levels have product family, class, and total products identifiers.
- `CUSTOMER`, which has two hierarchies of customer members, named `SHIPMENTS_ROLLUP` and `MARKET_ROLLUP`. The lowest level of each hierarchy has customer identification numbers and higher levels have warehouse, region, and total customers, and account, market segment, and total market identifiers, respectively.
- `TIME`, which has a hierarchy of calendar year time period identifiers.
- `CHANNEL`, which has a hierarchy of sales channel identifiers.

The `UNIT_COST` and `UNIT_PRICE` measures are dimensioned by the following two dimensions:

- `PRODUCT`
- `TIME`

For an example of a program that discovers the OLAP Catalog metadata for the schema, see [Chapter 4, "Discovering the Available Metadata"](#).

Access to Data and Metadata Through the OLAP API

Oracle OLAP metadata objects describe the data that is available to the OLAP API through a connection to the database. The metadata objects record three things:

- The existence of sets of data. For example, a measure of unit price figures, dimensions of product and time member values, and attributes that contain information about the members of the dimensions all exist as named entities in the data store.
- The structure of the sets of data. For example, the Unit Price measure is dimensioned by products and times, an attribute is dimensioned by the dimension for which it records information, and the members of the dimensions are organized into hierarchical levels.
- The characteristics of the data. For example, the Unit Price measure contains numeric values that are specified by the dimension member values, the dimension members have `String` values that identify the product or time values and the hierarchical levels, and the dimensions have attributes that provide additional information, such as a descriptive name for each dimension member that can be used in reports.

In contrast, the fact that the price of product 13 in month 55 was 2426.07 dollars is data, not metadata.

These examples distinguish between the metadata and the data for the measure of unit prices. The OLAP API makes a similar distinction between the metadata and the data

for dimensions. For example, the fact that a product dimension exists and that its members have text values is metadata. In contrast, the fact that the value of one of its members is 13 is data.

MDM Model in the OLAP API

The OLAP API multidimensional metadata (MDM) model describes data in multidimensional terms, which are familiar to OLAP and data warehousing audiences. For example, it includes objects for measures, dimensions, hierarchies, and attributes.

The following are some of the Java classes that are supplied by the OLAP API in its implementation of the MDM model:

- `MdmSchema`
- `MdmMetadataProvider`
- `MdmMeasure`
- `MdmDimension`
- `MdmHierarchy`
- `MdmLevel`
- `MdmAttribute`

An `MdmSchema` is a container for `MdmMeasure`, `MdmDimension`, and other `MdmSchema` objects. An `MdmSchema` corresponds to a measure folder in the OLAP management feature of Oracle Enterprise Manager. Note that an `MdmSchema` does not necessarily correspond to a relational schema.

An `MdmMetadataProvider` gives an application access to the MDM metadata objects that represent the OLAP metadata objects. To obtain the MDM metadata objects, an application uses the `getRootSchema` method of an `MdmMetadataProvider`. This method returns the top-level `MdmSchema`, which contains all of the `MdmDimension` objects that are accessible through this particular `MdmMetadataProvider`. The `MdmDimension` objects might be organized in a hierarchical tree, with subschemas nested under the top-level schema. Using the `getMeasureDimension`, `getSubSchemas`, and `getDimensions` methods of the top-level `MdmSchema`, and the `getSubSchemas`, `getMeasures`, and `getDimensions` methods of all of the nested `MdmSchema` objects, an application navigates through the metadata and discovers what data is available. In addition, the application can use methods to obtain the related `MdmMeasure`, `MdmHierarchy`, `MdmLevel`, and `MdmAttribute` objects.

[Chapter 2, "Understanding OLAP API Metadata"](#), provides detailed information about the OLAP API metadata.

Access to Data Through the OLAP API

An `MdmMeasure` or `MdmDimension` represents data in the data store. For example, an `MdmMeasure` object named `units` might represent a set of elements whose numeric values are dollar amounts for units sold, and an `MdmDimension` called `prodDim` might represent a set of members whose text values are product identifiers. However, an application cannot create a query on the data using an `MdmMeasure` or `MdmDimension`. As metadata, `MdmMeasure` and `MdmDimension` objects provide descriptive information about data, but they do not provide the ability to construct a query that specifies the data. To select, calculate, and otherwise manipulate data for analysis, an application must create a query.

To create a query on the data for an `MdmMeasure` or `MdmDimension`, an application must first get the `Source` object for the `MdmMeasure` or `MdmDimension` by calling `getSource` method of the metadata object. This method returns a `Source` object that the application can use to specify a query. The query defines a result set, and, in this case, the result set is the data for the `MdmMeasure` or `MdmDimension`.

In addition to representing the data for metadata objects, `Source` objects can represent the data for any query that an application creates. For example, a `Source` might specify a query for a selection of `MdmDimension` values (such as January, February, and March of the year 2002) or a calculation of the values of one `MdmMeasure` minus those of another (such as `unitPrice` minus `unitCost`). An application can use the powerful methods of the `Source` class and its subclasses to combine data in any way that the user requires.

To retrieve the data specified by a `Source`, an application creates a `Cursor` for that `Source`. The application then uses this `Cursor` to request and retrieve the data from the data store. When an application makes a request for data, it can specify the typical amount of data that it requires at a given time (for example, enough to fill a 40-cell table on the screen). Oracle OLAP then handles the issues related to efficient retrieval. The application does not need to manage the timing, sizing, and caching of the data blocks that it retrieves through the OLAP API.

Because the primary focus of most OLAP applications is making queries against the data store, a significant proportion of their data manipulation code works with the following classes, each of which has methods for selecting, calculating, and otherwise manipulating data.

- `Source`
- `BooleanSource`
- `DateSource`
- `NumberSource`
- `StringSource`

One of the useful characteristic of `Source` objects is that they make no distinction between attributes, dimensions, and measures. The `Source` objects for all of them behave in the same way.

Unique and Local Dimension Values

The members of an Oracle OLAP dimension are usually organized into one or more hierarchies. Some hierarchies have parent-child relationships based on levels and some have those relationships based on values. In the OLAP API a dimension always has at least one hierarchy dimension object and that hierarchy object has at least one level object. Even a nonhierarchical dimension is represented by a hierarchy dimension object with one level object.

The OLAP API uses a three-part format to specify the hierarchy, the level, and the value of a dimension member, and thus identify a unique value in the hierarchy. The first part of a unique value is the name of the hierarchy object, the second part is the name of the level object, and the third part is the value of the member in the level. The parts of the unique value are separated by a value separation string, which by default is double colons (: :). The following is an example of a unique member value in the `YEAR` level of the `CALENDAR` hierarchy of the `TIME` dimension:

```
CALENDAR::YEAR::2
```

The third part of a unique value is the local value. The local value in the preceding example identifies the year 1999.

The OLAP API has classes and methods that you can use to get the local values of dimension members. The `MdmPrimaryDimension` class has a method for getting an `MdmAttribute` that records the local values for the members of the hierarchies that are components of the `MdmPrimaryDimension`, and the `MdmDimensionMemberInfo` class has methods for getting the local or unique values for a member of a hierarchy or a level.

User Connection Requirements

In addition to ensuring that data and metadata have been prepared appropriately, an application developer must ensure that application users can make a connection to the data store through the OLAP API and that users have database privileges that give them access to the data. For information about setting up for such connections, see the *Oracle OLAP Application Developer's Guide*.

OLAP API Client Software

The OLAP API client software is a set of Java packages containing classes that implement the programming interface to Oracle OLAP. An application creates objects of these classes and calls their methods to discover metadata, specify queries, and retrieve data.

When a Java application calls methods of objects of OLAP API Java classes, it uses the OLAP API client software to communicate with Oracle OLAP, which resides within an Oracle database instance. The communication between the OLAP API client software and Oracle OLAP is provided through Java Database Connectivity (JDBC), which is a standard Java interface for connecting to relational databases. For more information about JDBC, see the *Oracle Database JDBC Developer's Guide and Reference*.

Requirements for Using the OLAP API Client Software

To use the OLAP API classes as you develop your application, import them into your Java code. When you deliver your application to users, include the OLAP API classes with the application. You must also ensure that users can access JDBC.

In order to develop an OLAP API application, you must have the Java Development Kit (JDK), such as one in Oracle JDeveloper or one from Sun Microsystems. Users must have a Java Runtime Environment (JRE) whose version number is compatible with the JDK that you used for development.

For information about Java version requirements and about setting up the OLAP API client software, see [Appendix A, "Setting Up the Development Environment"](#). For detailed information about the OLAP API classes and methods, see the *Oracle OLAP Java API Reference* and subsequent chapters of this guide.

Tasks That an OLAP API Application Performs

An application that uses the OLAP API typically performs the following tasks:

1. Connects to the data store
2. Discovers the available metadata
3. Specifies queries that select and manipulate data
4. Retrieves query results

The rest of this topic briefly describes these tasks, and the rest of this guide provides detailed information.

Task 1: Connect to the Data Store

An application connects to the data store by identifying some information about the target Oracle database and specifying this information in a JDBC connection method.

For more information about connecting, see [Chapter 3, "Connecting to a Data Store"](#).

Task 2: Discover the Available Metadata

Having established a connection, the application creates an `MdmMetadataProvider`. This object gives access to all of the metadata objects in the data store.

To discover the available metadata, an application uses the `getRootSchema` method of the `MdmMetadataProvider` to obtain the `MdmSchema` object that represents the top-level measure folder for all of the metadata objects to which the `MdmMetadataProvider` provides access. The application then gets the dimensions, including the measure dimension, and the subfolders that are under the root.

Once the application has all of the dimensions, it can interrogate them to get their attributes, hierarchies, levels, and other characteristics, and the measures. Having determined the metadata objects that it has to work with, the application can present relevant lists of objects to the user for data selection and manipulation.

For a description of the metadata objects, see [Chapter 2, "Understanding OLAP API Metadata"](#). For information about how an application can discover the available metadata, see [Chapter 4, "Discovering the Available Metadata"](#).

Task 3: Select and Calculate Data Through Queries

The heart of any OLAP application lies in the construction of queries against the data store. The application user interface provides ways for the user to select data and to specify what should be done with it. Then, the data manipulation code translates these instructions into queries against the data store. The queries can be as simple as a selection of dimension members, or they can be complex, including several aggregations and calculations on measure values specified by selections of dimension members.

The OLAP API object that specifies a query is a `Source`. Therefore, a significant portion of any OLAP API application is devoted to dealing with `Source` objects.

From an `MdmSchema`, you get `MdmSource` objects, such as an `MdmMeasure` or an `MdmPrimaryDimension`. You then get a `Source` object from the `MdmSource`. With the methods of a `Source` object, you can produce other `Source` objects that specify a selection of the elements of the `Source`, or that specify calculations or other operations to perform on the values of a `Source`.

If you are implementing a simple user interface, then you might use only the methods of the `Source` classes to select and manipulate the data that users specify in the interface. However, if you want to offer your users multistep selection procedures and the ability to modify queries or undo individual steps in their selections, you should design and implement `Template` classes. Within the code for each `Template`, you use the methods of the `Source` classes, but the `Template` classes themselves allow you to modify and refine even the most complex query. In addition, you can minimize your work by writing general-purpose `Template` classes and reusing them in various parts of your application.

For information about working with `Source` objects, see [Chapter 6, "Understanding Source Objects"](#). For information about working with `Template` objects, see [Chapter 11, "Creating Dynamic Queries"](#).

Task 4: Retrieve Query Results

When users of an OLAP application are selecting, calculating, combining, and generally manipulating data, they also want to see the results of their work. This means that the application must retrieve the result sets of queries from the data store and display the data in multidimensional form. To retrieve a result set for a query through the OLAP API, the application creates a `Cursor` for the `Source` that specifies the query.

An application can also get the SQL that Oracle OLAP generates for a query. To do so, the application creates a `SQLCursorManager` for the `Source` instead of creating a `Cursor`. The `generateSQL` method of the `SQLCursorManager` returns the SQL specified by the `Source`. The application can then retrieve the data by methods outside of the OLAP API. The `ExpressSQLCursorManager` class implements the `SQLCursorManager` interface.

Because the OLAP API was designed to deal with a multidimensional view of data, a `Source` can have a multidimensional result set. For example, a `Source` can represent an `MdmMeasure` that is structured by four `MdmPrimaryDimension` objects. Each `MdmPrimaryDimension` is represented by a `Source`. An application can create a query by joining the `Source` objects for the dimensions to the `Source` for the measure. The query has the measure data as its values and it has the `Source` objects for the dimensions as its outputs.

A `Cursor` for the query `Source` has the same structure as the `Source`; that is, the values of the `Cursor` are the measure data and the `Cursor` has four outputs. The values of the outputs are those of the `Source` objects for the dimensions.

To retrieve all of the items of data through a `Cursor`, the application can loop through the multidimensional `Cursor` structure. This design is well adapted to the requirements of standard user interface objects for painting the computer screen. It is especially well adapted to the display of data in multidimensional format.

For more information about using `Source` objects to specify a query, see [Chapter 6, "Understanding Source Objects"](#). For more information about using `Cursor` objects to retrieve data, see [Chapter 9, "Understanding Cursor Classes and Concepts"](#). For more information about the `SQLCursorManager` class, see the *Oracle OLAP Java API Reference*.

Understanding OLAP API Metadata

This chapter describes the metadata objects that the OLAP API provides, and explains how these objects relate to the permanent OLAP metadata objects that a database administrator specifies. The chapter also describes how an application can create transient custom metadata objects.

This chapter includes the following topics:

- [Overview of the OLAP API Metadata](#)
- [OLAP Metadata Objects](#)
- [Overview of MDM Metadata Objects in the OLAP API](#)
- [MdmDimension Classes](#)
- [MdmDimensionedObject Classes](#)
- [MdmMember Classes](#)
- [Data Type and Type of MDM Metadata Objects](#)
- [Creating Custom Metadata Objects](#)

For the complete code of the examples in this chapter, see the example programs available from the Overview of the *Oracle OLAP Java API Reference*.

Overview of the OLAP API Metadata

The OLAP API provides a Java application with access to a multidimensional view of data in an Oracle database. The OLAP API design includes objects that are consistent with that view and are familiar to data warehousing and OLAP developers. For example, it has objects for measures, dimensions, hierarchies, levels, and attributes. The OLAP API design incorporates an object-oriented model called MDM (multidimensional metadata).

To make the data in an Oracle database accessible to an OLAP API application as permanent MDM objects, a database administrator must map the relational data to OLAP metadata as described in *Oracle OLAP Application Developer's Guide*. An application can create transient custom metadata objects.

Data Preparation

A database administrator starts with a data warehouse that is organized according to certain specifications. For example, it might conform to a star schema. The requirements are described in *Oracle OLAP Application Developer's Guide*.

Metadata Preparation

The administrator creates OLAP metadata objects that Oracle OLAP maps to MDM metadata objects in the OLAP API. An application developer can discover the mapping of the MDM metadata objects to the relational tables and views, or create some custom MDM metadata objects, by using MTM (metadata mapping) objects. See [Chapter 5, "Working with Metadata Mapping Objects"](#), for more information on MTM objects.

The topic "[OLAP Metadata Objects](#)" briefly describes the OLAP metadata objects that a database administrator prepares for use with Oracle OLAP.

OLAP Metadata Objects

A database administrator creates Oracle OLAP metadata objects and can create one or more measure folders that contain one or more measures. The measures have dimensions and the dimensions have hierarchies, levels, and attributes. Each of these OLAP metadata objects maps directly to an MDM object in the OLAP API. For detailed information about creating OLAP metadata or about creating an analytic workspace, see *Oracle OLAP Application Developer's Guide*.

An application developer can create transient custom metadata objects that are based on the permanent metadata objects. The transient objects exist only in the context of an `MdmMetadataProvider` during a connection to the database.

Note that the OLAP metadata includes a cube object, which does not map directly to any MDM object. Database administrators create OLAP metadata cubes to specify the dimensions of each measure. Once the dimensions are specified, they are firmly associated with their measures in the metadata, so this type of cube object is not needed in the MDM model.

The rest of this topic briefly describes the OLAP metadata objects that map directly to MDM objects in the OLAP API.

Dimensions in the OLAP Metadata

The following are some of the characteristics that a database administrator can specify for dimensions:

- General characteristics, such as the name of the dimension and the database schema from which its elements are drawn. The elements of a dimension are also known as the members of the dimension.
- Hierarchies, which organize the members of the dimension into parent-child relationships. A hierarchy can be level-based or value-based. In a level-based hierarchy, the parent and child members are in different levels. A level-based hierarchy can have up to 31 levels. In a value-based hierarchy, the database administrator has defined the parent and child relationships by values rather than levels. A simple, nonhierarchical list of members is represented by a hierarchy that has only one level and that has no parent-child relationships defined for the members.
- Levels, which organize the members of a hierarchy into groups defined by the parent-child relationships for the hierarchy.
- Attributes, which record characteristics of the members for the dimension. For example, attributes record the level of each member of a level-based hierarchy and the depth of that level in the hierarchy.

Typically, a database administrator specifies one or more columns in a database table to serve as the basis for each OLAP level, hierarchy, and attribute.

A database administrator creates cubes after creating dimensions. An OLAP metadata cube identifies a set of measures that are dimensioned by the same set of dimensions.

Measures in the OLAP Metadata

A database administrator specifies that a measure belongs to an OLAP metadata cube, which also specifies the set of dimensions for the measure. This is essential information for the OLAP API, where the dimensionality of a measure is one of its most important features.

To identify the data for a measure, the database administrator typically specifies a column in a fact table where the data for the measure resides. As an alternative, the database administrator can specify a calculation or transformation that produces the data.

Measure Folders in the OLAP Metadata

Once a database administrator has created measures (after first creating dimensions and cubes), the next step is to create one or more groups of measures called measure folders. Typically, the measures in a given folder are related by subject matter. That is, they all pertain to the same business area. For example, there might be separate folders for financials, sales, and human resources data.

The measures in a measure folder can belong to different cubes and they can be from more than one relational schema. Measure folders can be nested, which means that a measure folder can have subfolders that have their own measures, and even their own subfolders. Thus, a database administrator can arrange measures in a hierarchy of folders, and an OLAP API `MdmMetadataProvider` can give access to all of the measure folders and their subfolders.

Overview of MDM Metadata Objects in the OLAP API

The OLAP API implementation of the MDM model is represented by classes in the `oracle.olapi.metadata.mdm` package. Most of the classes in this package implement metadata objects, such as dimensions and measures. [Figure 2-1](#) introduces the subclasses of the `MdmObject` class.

Figure 2–1 MdmObject Class and Its Subclasses

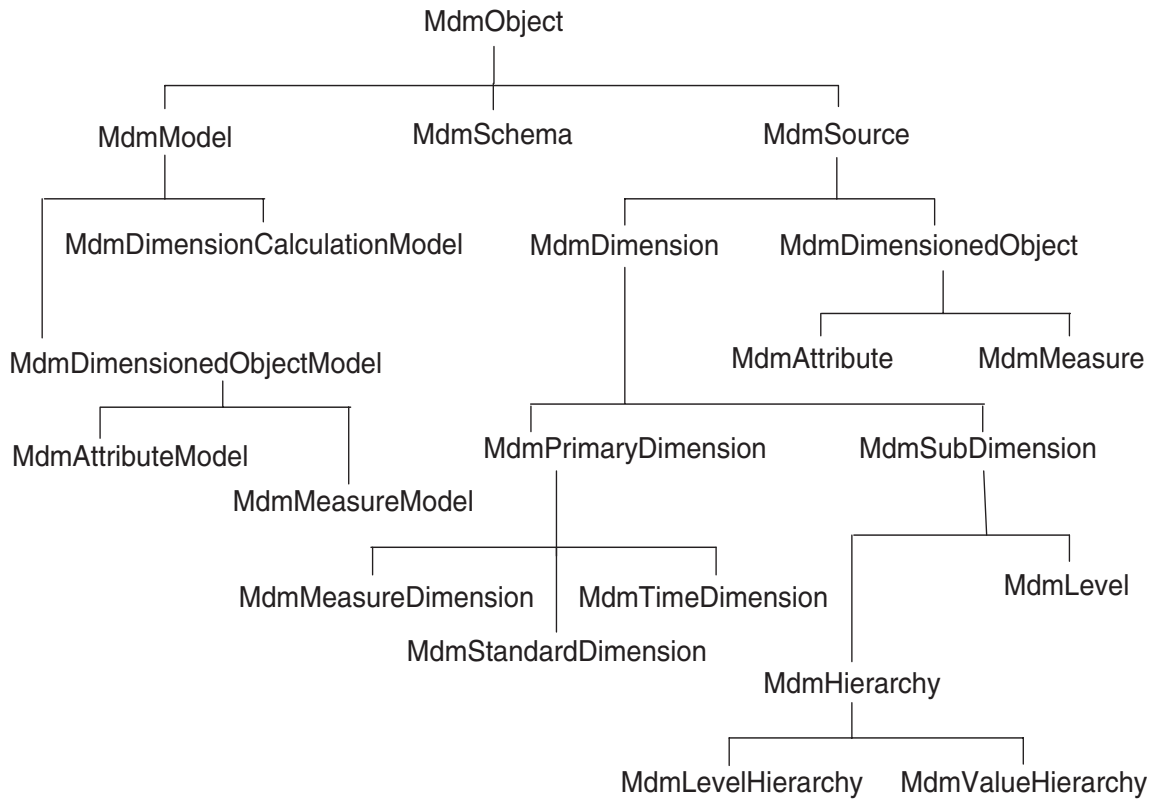

Mapping of OLAP Metadata Objects to MDM objects

An application gains access to metadata objects by creating an OLAP API `MdmMetadataProvider` and using it to discover the available metadata objects in the data store.

The Oracle OLAP metadata objects that a database administrator specifies map directly to MDM metadata objects that are accessible through the `MdmMetadataProvider`. The following table presents a typical mapping.

Oracle OLAP Metadata Objects	MDM Metadata Objects
Dimension	<code>MdmPrimaryDimension</code>
Hierarchy	<code>MdmLevelHierarchy</code> or <code>MdmValueHierarchy</code>
Level	<code>MdmLevel</code>
Measure	<code>MdmMeasure</code>
Attribute	<code>MdmAttribute</code>
Measure folder	<code>MdmSchema</code>

Some MDM metadata objects do not relate directly to OLAP metadata objects. For example, an `MdmCustomObjectFactory` object creates custom metadata objects, an `MdmMember` object represents a custom member of a dimension, or an `MdmMeasure`,

and an `MdmModel` object assigns values to an `MdmDimensionedObject` for one or more sets of members of its dimensions.

This chapter describes the MDM metadata objects. For information about how an application discovers the available MDM metadata objects in the data store, see [Chapter 4, "Discovering the Available Metadata"](#). MTM objects record the mapping of MDM objects to relational tables or views. For information on MTM objects, see [Chapter 5, "Working with Metadata Mapping Objects"](#).

`MdmModel`, `MdmSchema` and `MdmSource` are the subclasses of `MdmObject`.

MdmModel Class

The `MdmModel` class and its subclasses implement the `Model` interface for `MdmSource` objects. Because a `Model` is closely associated with a `Source`, the `Model` interface is in the `oracle.olapi.data.source` package. The `Model` interface is discussed in the topic ["Model Objects and Source Objects"](#) in [Chapter 6, "Understanding Source Objects"](#).

The `MdmModel` classes are an advanced feature of the OLAP API. When an application creates an `MdmMember` object, Oracle OLAP automatically creates an `MdmModel` for the `MdmMember` or adds information to an existing `MdmModel` object.

You can get an `MdmModel` for an `MdmPrimaryDimension` or an `MdmDimensionedObject` and use the `MdmModel` to specify the calculation of a value for a dimension member and the assignment of that value to the `Source` for a measure or attribute that is dimensioned by the dimension. For more information on `MdmMember` classes and examples of creating custom dimension members and using `MdmModel` objects, see ["MdmMember Classes"](#) and ["Creating Custom Metadata Objects"](#).

The subclasses of `MdmModel` are `MdmDimensionCalculationModel` and `MdmDimensionedObjectModel`. An `MdmDimensionedObject` object has an associated `MdmDimensionedObjectModel` that represents the assignment of zero or more values for the `Source` for the `MdmDimensionedObject`. You can get the `MdmDimensionedObjectModel` for an `MdmDimensionedObject` by calling its `getModel` method. The concrete subclasses of `MdmDimensionedObjectModel` are `MdmAttributeModel` and `MdmMeasureModel`.

An `MdmDimensionCalculationModel` assigns values for a measure of a particular data type. An `MdmPrimaryDimension` object has `MdmDimensionCalculationModel` objects for the OLAP API data types `Boolean`, `Date`, `Number`, and `String`. The `MdmMeasureDimension` subclass of `MdmPrimaryDimension` has a `MdmDimensionCalculationModel` for the `Value` data type, as well. You get an `MdmDimensionCalculationModel` for a specific data type by calling a method of an `MdmPrimaryDimension`, such as the `getStringCalcModel` method. Calling the `getModel` method of an `MdmPrimaryDimension` returns `null`.

The subclasses of `MdmSubDimension`, and the `MdmStandardMember` and `MdmTimeMember` classes, do not have associated `MdmModel` objects. Calling the `getModel` method of an `MdmSubDimension`, `MdmStandardMember`, or `MdmTimeMember` returns `null`.

MdmSchema Class

An `MdmSchema` represents a set of data that is used for navigational purposes. It is a container for `MdmMeasure`, `MdmPrimaryDimension`, and other `MdmSchema` objects. An `MdmSchema` is equivalent to a folder or directory that contains associated items. It

does not correspond to a relational schema in the Oracle database. Instead, it corresponds to an Oracle OLAP measure folder, which can include data from several relational schemas and which was created by a database administrator. You can create a custom `MdmSchema` with the `createSchema` method of an `MdmCustomObjectFactory`.

Data that is accessible through the OLAP API is arranged under a top-level `MdmSchema`, which is referred to as the root `MdmSchema`. Under the root schema, there can be one or more subschemas. To begin navigating the metadata, an application calls the `getRootSchema` method of the `MdmMetadataProvider`, as explained in [Chapter 4, "Discovering the Available Metadata"](#).

The root `MdmSchema` contains all of the `MdmDimension` objects that are in the data store. Most `MdmPrimaryDimension` objects are also contained in subschemas under the root `MdmSchema`. However, a data store can contain a dimension that is not included in a subschema. The root `MdmSchema` contains all of the available dimension objects, including those that are in subschemas as well as any dimension objects that are not.

The root `MdmSchema` contains `MdmMeasure` objects only if they are not contained in a subschema. Because most `MdmMeasure` objects belong to a subschema, the root `MdmSchema` typically has no `MdmMeasure` objects. Therefore, the `getMeasures` method of the root `MdmSchema` typically returns an empty `List` object.

An `MdmSchema` has methods for getting all of the `MdmMeasure`, `MdmPrimaryDimension`, and `MdmSchema` objects that it contains. The root `MdmSchema` also has a method for getting the `MdmMeasureDimension`, whose members are all of the `MdmMeasure` objects in the data store regardless of whether they belong to a subschema.

MdmSource Class

`MdmSource` objects represent data that is available to an application. With the `getSource` method of an `MdmSource`, an application gets a `Source` object that it can use to create a query. The following line of code gets the `Source` for an `MdmStandardDimension` called `mdmProductDim`.

```
Source productDim = mdmProductDim.getSource();
```

A `Source` that is the result of the `getSource` method of an `MdmSource` is called a primary `Source`. An application derives new `Source` objects from this primary `Source` as it selects, calculates, and otherwise manipulates the data. When the application derives a `Source` that represents the query that it wants to make, it creates a `Cursor` for the `Source`. The `Cursor` retrieves the data.

For more information about working with `Source` and `Cursor` objects, see [Chapter 6, "Understanding Source Objects"](#) and [Chapter 9, "Understanding Cursor Classes and Concepts"](#). The rest of this chapter describes the subclasses of `MdmSource`.

MdmDimension Classes

`MdmDimension` is an abstract subclass of `MdmSource` that represents the general concept of a list of members that can organize a set of data. For example, if you have a set of figures that are the prices of product items during month time periods, then the unit price data is represented by an `MdmMeasure` that is dimensioned by dimensions for time and product values. The time dimension includes the month values and the product dimension includes item values. The month and item values act as indexes for identifying each particular value in the set of unit price data.

An `MdmDimension` can have one or more `MdmAttribute` objects. An `MdmAttribute` maps the value of each member of the `MdmDimension` to a value representing some characteristic of the member value. To obtain the `MdmAttribute` objects for an `MdmDimension`, call its `getAttributes` method or the methods that return specific attributes, such as the `getHierarchyAttribute` or the `getParentAttribute` method.

`MdmDimension` has the abstract subclasses `MdmPrimaryDimension` and `MdmSubDimension`.

MdmPrimaryDimension Classes

`MdmPrimaryDimension` is an abstract subclass of `MdmDimension`. The concrete subclasses of the `MdmPrimaryDimension` class represent different types of data. The concrete subclasses of `MdmPrimaryDimension` are the following:

- `MdmMeasureDimension`, which has all of the `MdmMeasure` objects in the data store as the values of its members. A data store has only one `MdmMeasureDimension`. You can obtain the `MdmMeasureDimension` by calling the `getMeasureDimension` method of the root `MdmSchema` and casting the result to an `MdmMeasureDimension`. You can get the measures of the data store by calling the `getMeasures` method of the `MdmMeasureDimension`.
- `MdmStandardDimension`, which has no special characteristics, and which typically represent dimensions of products, customers, distribution channels, and so on.
- `MdmTimeDimension`, which has time periods as the values of its members. Each time period has an end date and a time span. An `MdmTimeDimension` has methods for getting the attributes that record that information.

An `MdmPrimaryDimension` has one or more component `MdmHierarchy` objects, which represent the hierarchies of the dimension. An `MdmPrimaryDimension` has all of the members of its component `MdmHierarchy` objects, while each of its `MdmHierarchy` objects has only the members in that hierarchy.

An `MdmPrimaryDimension` that represents a nonhierarchical list of members has only one `MdmLevelHierarchy`, which has all of its members at one level with no hierarchical relationships defined for them. For example, the `MdmMeasureDimension` represents a dimension that is simple list of the `MdmMeasure` objects in the data store. The `MdmMeasureDimension` has one `MdmLevelHierarchy`, which has one `MdmLevel`. The `MdmMeasureDimension`, its `MdmLevelHierarchy`, and its `MdmLevel` all have the same dimension members, the values of which are the `MdmMeasure` objects.

MdmSubDimension Classes

`MdmSubDimension` is an abstract subclass of `MdmDimension`. The subclasses of `MdmSubDimension` are `MdmHierarchy` and `MdmLevel`.

MdmHierarchy

`MdmHierarchy` is an abstract subclass of `MdmSubDimension`. An `MdmHierarchy` represents an organization of the members of an `MdmPrimaryDimension`, which can have more than one hierarchy defined for it. For example, an `MdmTimeDimension` dimension might have two hierarchies, one organized by calendar year time periods and the other organized by fiscal year time periods. The members of both hierarchies are drawn from the members of the `MdmTimeDimension`, but the number of members

in each hierarchy and the parent-child relationships of the values of the members can be different.

The parent-child relationships of an `MdmHierarchy` are recorded in a parent `MdmAttribute`, which you can get by calling the `getParentAttribute` method of the `MdmHierarchy`. The ancestor-descendent relationships are specified in an `ancestors MdmAttribute`, which you can get by calling the `getAncestorsAttribute` method.

MdmLevelHierarchy

`MdmLevelHierarchy` is a concrete subclass of `MdmHierarchy`. An `MdmLevelHierarchy` has its parent-child relationships defined between the values of the members at different levels. The different levels of an `MdmLevelHierarchy` are represented by `MdmLevel` objects. An `MdmLevelHierarchy` can have up to 31 component `MdmLevel` objects. An `MdmLevelHierarchy` has a tree-like structure. The members at the lowest level of the hierarchy are the leaves, and the members at higher levels are nodes. Nodes have children; leaves do not.

The `MdmLevelHierarchy` has all of the members of the hierarchy, and each of its component `MdmLevel` objects has only the members at the level it represents. Each member, except those at the highest level, can have a parent, and each member, except those at the lowest level, can have one or more children. The parent and children of a member of an `MdmLevel` are in other `MdmLevel` objects. An `MdmLevelHierarchy` can also represent a nonhierarchical list of members, in which case the `MdmLevelHierarchy` has one `MdmLevel`, and both objects have the same members. You get the levels of an `MdmLevelHierarchy` by calling its `getLevels` method.

MdmValueHierarchy

`MdmValueHierarchy` is the other concrete subclass of `MdmHierarchy`. An `MdmValueHierarchy` has parent-child relationships defined between the values of the dimension members, and does not have the parent and child members at different levels. An example of a value hierarchy is the employee reporting structure of a company, which can be represented with parent-child relationships but without levels. A database administrator defines a dimension as a value hierarchy in the Oracle OLAP metadata. An application developer can define a value hierarchy with the `createValueHierarchy` method of an `MdmCustomObjectFactory` or an `MdmPrimaryDimension`.

MdmLevel

`MdmLevel` is a concrete subclass of `MdmSubDimension`. An `MdmLevel` represents a set of members that supply one level of the hierarchical structure of an `MdmLevelHierarchy`.

An `MdmLevel` represents a level that was specified by a database administrator in the OLAP metadata or that is a custom `MdmLevel`. Typically, a database administrator specifies a column in a relational database table or view to provide the values of the level, or an application specifies a column in an `MtmExpression`. The values of the members of an `MdmLevel` must be unique. If the column in the database has values that are not unique, then the database administrator can define the members of a level using two or more columns of the table, thus ensuring that the members of the `MdmLevel` have unique values. For example, if a dimension of geographical locations has a level for cities and more than one city has the same name, then a database administrator can specify as the value of the city level both the city column and the state column in the relational database. The values of the members in the `MdmLevel`

for cities are then combinations of the two column values, such as `IL:Springfield` for Springfield, Illinois and `MA:Springfield` for Springfield, Massachusetts.

An `MdmLevelHierarchy` has one `MdmLevel` for each level of members in the hierarchy of dimension members that it represents. Each member of an `MdmLevel`, except the highest level, can have a parent, and each member, except those of the lowest level, can have one or more children. The parent and children of members of one `MdmLevel` are members from other `MdmLevel` objects.

The parent-child relationships among the members are recorded in the parent and ancestors attributes, which you can obtain by calling the `getParentAttribute` and `getAncestorsAttribute` methods of the `MdmLevelHierarchy` of which the `MdmLevel` is a component. You can get the `MdmLevelHierarchy` for the `MdmLevel` by calling the `getLevelHierarchy` method of the `MdmLevel`.

MdmDimensionedObject Classes

`MdmDimensionedObject` is an abstract subclass of `MdmSource` that represents objects the values of which are specified by members of one or more dimensions. The subclasses of `MdmDimensionedObject` are `MdmMeasure` and `MdmAttribute`.

MdmMeasure

An `MdmMeasure` represents a set of data that is organized by one or more `MdmDimension` objects. The structure of the data is similar to that of a multidimensional array. Like the dimensions of an array, which provide the indexes for identifying a specific cell in the array, the `MdmDimension` objects that organize an `MdmMeasure` provide the indexes for identifying a specific value of an element of the `MdmMeasure`.

For example, suppose you have an `MdmMeasure` that has data that records the number of product units sold to a customer during a time period and through a sales channel. The data of the measure is organized by dimensions for products, times, customers, and channels (with channel representing the sales avenue, such as catalog or internet.). You can think of the data as occupying a four-dimensional array with the product, time, customer, and channel dimensions providing the organizational structure. The values of these four dimensions are indexes for identifying each particular cell in the array, which contains a single units sold data value. You must specify a value for each dimension in order to identify a value in the array. In relational terms, the `MdmDimension` objects constitute a compound (that is, composite) primary key for the `MdmMeasure`.

The values of an `MdmMeasure` are usually numeric, but a measure can have values of other data types.

A persistent `MdmMeasure` is based on an OLAP metadata measure that was created by a database administrator. In most cases, the `MdmMeasure` maps to a column in a fact table or to an expression that specifies a mathematical calculation or a data transformation. In many but not all cases, the `MdmMeasure` also maps to at least one hierarchy for each OLAP dimension of the measure, as well as an aggregation method. Oracle OLAP uses all of this information to identify the number of elements in the `MdmMeasure` and the value of each element.

An application can create a transient custom `MdmMeasure`, and make it a member of the `MdmMeasureDimension`, by calling a `createCustomMeasure` method of the `MdmMeasureDimension` or a method of `MdmCustomObjectFactory`.

The set of elements that are in an `MdmMeasure` is determined by the structure of its `MdmDimension` objects. That is, each element of an `MdmMeasure` is identified by a unique combination of members from its `MdmDimension` objects. That combination of dimension members is called a tuple.

The `MdmDimension` objects of an `MdmMeasure` are `MdmStandardDimension` or `MdmTimeDimension` objects. They usually have at least one hierarchical structure. Those `MdmPrimaryDimension` objects include all of the members of their component `MdmHierarchy` objects. Because of this structure, the values of the elements of an `MdmMeasure` are of one or more of the following:

- Values from the fact table column, view, or calculation on which the `MdmMeasure` is based. These values belong to `MdmMeasure` elements that are identified by a combination of values from the members at the leaf level of an `MdmHierarchy`.
- Aggregated values that Oracle OLAP has provided. These values belong to `MdmMeasure` elements that are identified by the value of at least one member from a node level of an `MdmHierarchy`.
- Values assigned by an `MdmModel` for a custom dimension member.

As an example, imagine an `MdmMeasure` called `mdmUnitCost` that is dimensioned by an `MdmTimeDimension` called `mdmTimeDim` and an `MdmStandardDimension` of products called `mdmProdDim`. Each of the `mdmTimeDim` and the `mdmProdDim` objects has all of the leaf members and node members of the dimension it represents.

A unique combination of two members, one from `mdmTimeDim` and one from `mdmProdDim`, identifies each `mdmUnitCost` element, and every possible combination is used to specify the entire `mdmUnitCost` element set.

Some `mdmUnitCost` elements are identified by a combination of leaf members (for example, a particular product item and a particular month). Other `mdmUnitCost` elements are identified by a combination of node members (for example, a particular product family and a particular quarter). Still other `mdmUnitCost` elements are identified by a mixture of leaf and node members. The values of the `mdmUnitCost` elements that are identified only by leaf members come directly from the column in the database fact table (or fact table calculation). They represent the lowest level of data. However, for the elements that are identified by at least one node member, Oracle OLAP provides the values. These higher-level values represent aggregated, or rolled-up, data.

Thus, the data represented by an `MdmMeasure` is a mixture of fact table data from the data store, aggregated data that Oracle OLAP makes available for analytical manipulation, and possibly values that Oracle OLAP assigns as specified by an `MdmModel`.

MdmAttribute Class

`MdmAttribute` is a concrete subclass of `MdmDimensionedObject` that represents a particular characteristic of the members of an `MdmDimension`. An `MdmAttribute` maps a member of the `MdmDimension` to a particular value.

For example, `mdmCustDim` is the `MdmPrimaryDimension` for the Customer dimension. The `MdmPrimaryDimension` has a hierarchy that has levels that are based on shipment origination and destination values. The `MdmAttribute` returned by the `getShortValueDescriptionAttribute` method of `mdmCustDim` relates a short description to each the member of the dimension. The elements of the `MdmAttribute` have `String` values such as `Europe`, `Italy`, or `Computer Services Athens`.

The elements of an `MdmAttribute` might have `String` values (such as Italy), numeric values (such as 45), or objects (such as `MdmLevel` objects).

Like an `MdmMeasure`, an `MdmAttribute` has elements that are organized by its `MdmDimension`. Sometimes an `MdmAttribute` does not have a value for every member of its `MdmDimension`. For example, an `MdmAttribute` that records the name of a contact person might have values only for the Ship To and Warehouse levels of the Shipments Rollup hierarchy of the `mdmCustDim` dimension, because contact information does not apply to the higher Region and All Customers levels. If an `MdmAttribute` does not apply to a member of an `MdmDimension`, then the `MdmAttribute` element value for that member is `null`.

An `MdmAttribute` object can provide a mapping that is one-to-many, rather than one-to-one. Therefore, a member in an `MdmDimension` might map to a whole set of `MdmAttribute` elements. For example, the `MdmAttribute` that serves as the ancestors attribute for an `MdmHierarchy` maps each `MdmHierarchy` member to its set of ancestor `MdmHierarchy` members.

An `MdmAttribute` is based on an OLAP attribute that was specified for a dimension, hierarchy, or level by a database administrator or that was specified by an `MtmValueExpression` for a custom `MdmAttribute` created by an application.

The following table lists the values of elements of a `Source` object that represents the members of a hierarchy of an `MdmPrimaryDimension` of products. The table also lists the values of the `Source` objects for two `MdmAttribute` objects that are dimensioned by the `MdmPrimaryDimension`. One attribute is the short description attribute for the dimension. Each member of the dimension has a related short description. The other is a custom attribute that relates a color to the values of members at the Item level, which is the lowest level of the hierarchy. The values of the color `MdmAttribute` are `null` for the aggregate Total Product, Class, and Family levels. In the table, `null` values appear as NA.

Product Values	Related Short Descriptions	Related Colors
PRODUCT_ROLLUP::TOTAL_PRODUCT::1	Total Product	NA
PRODUCT_ROLLUP::CLASS::2	Hardware	NA
PRODUCT_ROLLUP::FAMILY::4	Portable PCs	NA
PRODUCT_ROLLUP::ITEM::13	Envoy Standard	Black
PRODUCT_ROLLUP::ITEM::14	Envoy Executive	Black
PRODUCT_ROLLUP::ITEM::15	Envoy Ambassador	Black
PRODUCT_ROLLUP::FAMILY::5	Desktop PCs	NA
PRODUCT_ROLLUP::ITEM::16	Sentinel Standard	Beige
PRODUCT_ROLLUP::ITEM::17	Sentinel Financial	Beige
PRODUCT_ROLLUP::ITEM::18	Sentinel Multimedia	Beige
...

MdmMember Classes

`MdmMember` is an interface that specifies characteristics of a custom dimension member. [Figure 2-2](#) shows the classes that implement the interface.

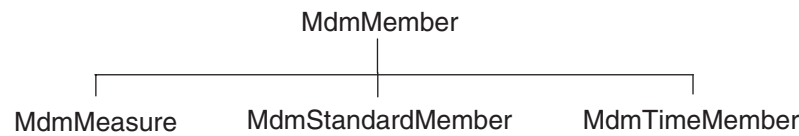
Figure 2–2 MdmMember Interface and Its Implementations

You can add a custom member to an `MdmStandardDimension` or an `MdmTimeDimension` by calling a `createStandardCustomMember` method or a `createTimeCustomMember` method of an `MdmCustomObjectFactory`. You can also use one of the `addCustomMember` convenience methods of the `MdmStandardDimension` or the `MdmTimeDimension`.

You can create an `MdmMeasure` and add it as a custom member of the `MdmMeasureDimension` by calling a `createCustomMeasure` method of an `MdmCustomObjectFactory`. You can also use one of the `createCustomMeasure` convenience methods of the `MdmMeasureDimension`.

When you create a custom member, you specify a `Source` that provides the value that Oracle OLAP assigns as the measure or attribute value for the custom member. That `Source` can specify a constant value or it can specify a calculation to perform. Custom dimension members are therefore `Source`-based dimension members, in that the measure or attribute value that Oracle OLAP assigns for the custom member is provided by the `Source` that the application supplies. The measure or attribute values specified by other members of a dimension, which are not instances of `MdmMember`, are not based on a `Source` but instead are mapped to data derived from columns in tables or views in the database.

[Example 2–1](#) creates a custom member of the Product dimension. The measure value specified for the custom member is the result of a calculation.

In the example, `dp` is the `DataProvider`. The example gets the placeholder `Source`, `ph`, for the Number data type from the `DataProvider`. If a query specifies the values for more than one measure that is dimensioned by the Product dimension, then the placeholder `Source` represents the current measure in the query.

The example uses the placeholder in defining the calculation object, `calc`. The calculation object defines the value assigned for the custom member as the value specified by product item 14 plus the value specified by item 15.

In the `createCustomMember` method call, the local value of the custom dimension member is 60. In creating the custom member, Oracle OLAP supplies the other parts of the unique value. The unique value for the member is `PRODUCT_ROLLUP::ITEM::60`. The `itemLevel` object is the `MdmLevel` for the custom member. The local value of the parent of the custom member is 4. The `calc` object is the value that Oracle OLAP assigns for the member as the measure value for a measure dimensioned by the Product dimension, and 10 is the precedence value for the custom member.

The `prodSel` object specifies the dimension members for items 14 and 15 and the custom member, item 60. The `unitCost` and `unitPrice` objects are `Source` objects for the Unit Cost and Unit Price measures, and the `calendar` object is the `Source` for the Calendar hierarchy of the Time dimension.

The `result` object is the query produced by joining the `Source` objects for the Unit Cost and Unit Price price measures to the `Source` objects for the selected members of the dimensions of the measures. The `join` method used to join the Time dimension

value, `CALENDAR::MONTH::47`, to the result of the previous join operations causes the Time value to not appear in the result object.

Example 2-1 Creating a Custom Member of a Dimension

```
Source ph = dp.getFundamentalMetadataProvider()
            .getNumberPlaceholder()
            .getSource();

Source calc = ((NumberSource)
              (ph.join(prodRollup, "PRODUCT_ROLLUP::ITEM::14")))
              .plus(
              (NumberSource)
              (ph.join(prodRollup, "PRODUCT_ROLLUP::ITEM::15")));

MdmStandardMember mdmItem60 = mdmProdStdDim.createCustomMember(
                                "60", // member local value
                                mdmItemLevel, // member level
                                "4", // parent local value
                                calc, // calculation Source
                                10); // precedence value

StringSource prodSel = prodRollup.selectValues(
                            new String[]{"PRODUCT_ROLLUP::ITEM::14",
                                        "PRODUCT_ROLLUP::ITEM::15",
                                        "PRODUCT_ROLLUP::ITEM::60"});

Source result = unitPrice.join(unitCost)
                    .join(prodSel)
                    .join(calendar, "CALENDAR::MONTH::47");
```

A Cursor for result has the following values, with column headings and formatting added:

Product Item	Cost	Price
PRODUCT_ROLLUP::ITEM::14	3238.36	3442.86
PRODUCT_ROLLUP::ITEM::15	2847.47	2962.14
PRODUCT_ROLLUP::ITEM::60	6085.83	6405.00

For an example of creating a custom `MdmMeasure` as a member of an `MdmMeasureDimension`, see [Example 2-4](#).

Like Template objects, custom dimension members exist in the context of a Transaction. Also, custom members are not persistent; they are not stored in the database after the application closes the `DataProvider`. For information on the Transaction and Template classes, see [Chapter 8, "Using a TransactionProvider"](#) and [Chapter 11, "Creating Dynamic Queries"](#).

Custom members can only be used by the OLAP API application. They are not available to an OLAP DML or SQL application.

Data Type and Type of MDM Metadata Objects

All `MdmSource` objects have the following two basic characteristics:

- Data type
- Type

`MdmDimensionCalculationModel` objects also have a data type and a type.
`MdmDimensionedObjectModel` objects have a type but not a data type.

Data Type of MDM Metadata Objects

The concept of data type is a familiar one in computer languages and database technology. It is common to categorize data into types such as integer, Boolean, and String.

The OLAP API implements the concept of data type through the `FundamentalMetadataObject` and `FundamentalMetadataProvider` classes. Every data type recognized by the OLAP API is represented by a `FundamentalMetadataObject`, and you obtain this object by calling a method of a `FundamentalMetadataProvider`.

The following table lists the most familiar OLAP API data types. For each data type, the table presents a description of the `FundamentalMetadataObject` that represents the data type and the name of the method of `FundamentalMetadataProvider` that returns the object. The OLAP API data types appear in regular typeface, instead of monospace typeface, to distinguish them from `java.lang` data type classes.

OLAP API Data Type	Description of the <code>FundamentalMetadataObject</code>	Method of <code>FundamentalMetadataProvider</code>
Boolean	Represents the data type that corresponds to the Java <code>boolean</code> data type.	<code>getBooleanDataType</code>
Date	Represents the data type that corresponds to the Java <code>Date</code> class.	<code>getDateDataType</code>
Double	Represents the data type that corresponds to the Java <code>double</code> data type.	<code>getDoubleDataType</code>
Float	Represents the data type that corresponds to the Java <code>float</code> data type.	<code>getFloatDataType</code>
Integer	Represents the data type that corresponds to the Java <code>int</code> data type	<code>getIntegerDataType</code>
Short	Represents the data type that corresponds to the Java <code>short</code> data type.	<code>getShortDataType</code>
String	Represents the data type that corresponds to the Java <code>String</code> class.	<code>getStringDataType</code>

In addition to these familiar data types, the OLAP API includes two generalized data types (which represent groups of the familiar data types) and two data types that represent the absence of values. The following table lists these additional data types.

OLAP API Data Type	Description of the <code>FundamentalMetadataObject</code>	Method of <code>FundamentalMetadataProvider</code>
Number	Represents a general data type that includes any or all of the following OLAP API numeric data types: Double, Float, Integer, and Short	<code>getNumberDataType</code>

OLAP API Data Type	Description of the FundamentalMetadataObject	Method of FundamentalMetadataProvider
Value	Represents a general data type that includes any or all of the OLAP API data types.	getValueDataType
Empty	Represents no data, for example when an MdmSource has no elements at all defined for it.	getEmptyDataType
Void	Represents null data, for example when an MdmSource has a single element that has a null value.	getVoidDataType

When an MDM metadata object, such as an `MdmMeasure`, has a given data type, this means that each of its elements conforms to that data type. If the data type is numeric, then the elements also conform to the generalized `Number` data type, as well as to the specific data type (`Double`, `Float`, `Integer`, or `Short`). The elements of any MDM metadata object conform to the `Value` data type, as well as to their more specific data type, such as `Integer` or `String`.

If the elements of an object represent a mixture of several numeric and non-numeric data types, then the data type is only `Value`. The object has no data type that is more specific than that.

The MDM metadata objects for which data type is relevant are `MdmDimensionCalculationModel` objects and `MdmSource` objects, such as `MdmMeasure`, `MdmLevelHierarchy`, and `MdmLevel`. The typical data type of an `MdmMeasure` is one of the numeric data types; the data type of an `MdmLevelHierarchy` or `MdmLevel` is always `String`.

An `MdmPrimaryDimension` has a set of `MdmDimensionCalculationModel` objects, each of which has a different data type. If an `MdmDimensionCalculationModel` has an `Assignment`, then Oracle OLAP assigns the specified value to measures that have the same data type as the `MdmDimensionCalculationModel`. For example, the data type of the `MdmDimensionCalculationModel` returned by the `getNumberCalcModel` method of an `MdmStandardDimension` is the `FundamentalMetadataObject` for the `Number` data type. An `Assignment` specified by that `MdmDimensionCalculationModel` applies only to a measure that has a `Number` data type and that is dimensioned by the `MdmStandardDimension`.

Getting the Data Type of an MdmSource

To find the data type of an `MdmSource` or `MdmDimensionCalculationModel`, call its `getDataType` method. That method returns a `FundamentalMetadataObject`.

To find the OLAP API data type that is represented by the returned `FundamentalMetadataObject`, you could compare it to the `FundamentalMetadataObject` for each OLAP API data type. That is, you compare it to the return value of each of the data type methods in `FundamentalMetadataProvider`.

The following sample method returns a `String` that indicates the data type of an `MdmSource`. Note that this code gets the `FundamentalMetadataProvider` by calling a method of a `DataProvider`. Getting a `DataProvider` is described in [Chapter 4, "Discovering the Available Metadata"](#).

Example 2-2 Getting the Data Type of an MdmSource

```

public String getDataType(DataProvider dp, MdmSource metaSource)
{
    String theDataType = null;
    FundamentalMetadataProvider fmp =
        dp.getFundamentalMetadataProvider();

    if (fmp.getBooleanDataType() == metaSource.getDataType())
        theDataType = "Boolean";
    else if (fmp.getDateDataType() == metaSource.getDataType())
        theDataType = "Date";
    else if (fmp.getDoubleDataType() == metaSource.getDataType())
        theDataType = "Double";
    else if (fmp.getFloatDataType() == metaSource.getDataType())
        theDataType = "Float";
    else if (fmp.getIntegerDataType() == metaSource.getDataType())
        theDataType = "Integer";
    else if (fmp.getShortDataType() == metaSource.getDataType())
        theDataType = "Short";
    else if (fmp.getStringDataType() == metaSource.getDataType())
        theDataType = "String";
    else if (fmp.getNumberDataType() == metaSource.getDataType())
        theDataType = "Number";
    else if (fmp.getValueDataType() == metaSource.getDataType())
        theDataType = "Value";

    return theDataType;
}

```

Type of MDM Metadata Objects

An MDM metadata object, such as an `MdmSource`, is a collection of elements. Its type (as opposed to its data type) is another metadata object from which the metadata object draws its elements. In other words, the elements of a metadata object correspond to a subset of the elements in its type. There can be no element in the metadata object that does not match an element of its type.

Consider the following example of a `MdmPrimaryDimension` called `mdmCustDim`, which has the OLAP API data type of `String`. The `mdmCustDim` dimension has a hierarchy, which is an `MdmLevelHierarchy` object called `mdmShipmentsRollup`, which in turn has levels, which are `MdmLevel` objects. The `MdmLevelHierarchy` and the `MdmLevel` objects represent subsets of the members of the `MdmPrimaryDimension`. In the following list, the hierarchy and the levels are indented under the `MdmPrimaryDimension` to which they belong.

```

mdmCustDim
  mdmShipmentsRollup
    mdmTotalCust
    mdmRegion
    mdmWarehouse
    mdmShipTo

```

Because of the hierarchical structure, `mdmWarehouse` (for example) draws its members from the members of `mdmShipmentsRollup`. That is, the set of members for `mdmWarehouse` corresponds to a subset of members from `mdmShipmentsRollup`, and `mdmShipmentsRollup` is the type of `mdmWarehouse`.

Similarly, `mdmShipmentsRollup` is a component hierarchy of `mdmCustDim`. Therefore, `mdmShipmentsRollup` draws its members from `mdmCustDim`, which is its type.

However, `mdmCustDim` is not a component of any other object. It represents the entire dimension. The pool of elements from which `mdmCustDim` draws its members is the entire set of possible `String` values. Therefore, the type of `mdmCustDim` is the `FundamentalMetadataObject` that represents the OLAP API `String` data type. In the case of `mdmCustDim`, the type and the data type are the same.

The following list presents the types that are typical for the most common `MdmSource` objects:

- The type of an `MdmLevel` is the `MdmLevelHierarchy` to which it belongs.
- The type of a `MdmHierarchy` is the `MdmPrimaryDimension` to which it belongs.
- The type of an `MdmPrimaryDimension` is the `FundamentalMetadataObject` that represents its OLAP API data type. Typically, this is the `String` data type.
- The type of an `MdmMeasure` is the `FundamentalMetadataObject` that represents its OLAP API data type. Typically, this is one of the OLAP API numeric data types.

An `MdmModel` also has a type, which is the `Source` from which Oracle OLAP draws the values that the `MdmModel` assigns. For example, the type of the `MdmDimensionedObjectModel` for the `MdmAttribute` for the short value description attribute of the `Product` dimension is the `Source` for the `FundamentalMetadataObject` for the `String` data type because the values of that attribute are `String` objects.

Getting the Type of an MdmSource

To find the type of an `MdmSource` that you have obtained from the data store, call its `getType` method. That method returns the object that is the type of the `MdmSource` object.

For example, the following Java statement obtains the type of the `MdmLevel` named `mdmWarehouse`.

Example 2-3 Getting the Type of an MdmSource

```
MetadataObject mdmWarehouseType = mdmWarehouse.getType();
```

Creating Custom Metadata Objects

An application developer can create transient custom metadata objects with methods of an `MdmCustomObjectFactory` or with convenience methods of the subclasses of `MdmPrimaryDimension`, or with methods of an `MdmLevelHierarchy` or an `MtmPartitionedCube`. The custom metadata objects exist in the context of a `Transaction`.

[Example 2-4](#) demonstrates the creation of a custom `MdmMeasure` as a member of the `MdmMeasureDimension` of the root `MdmSchema`. The example gets the root `MdmSchema` from the `MdmMetadataProvider`, gets the top-level `MdmMeasureDimension` from root `MdmSchema`, and then gets the `Source` for the `MdmMeasureDimension`, cast as a `StringSource`.

Next, the example creates a `Source`, calculation, that specifies the values for the custom measure. The values are the result of the calculation unit price minus unit cost. The `unitPrice` and `unitCost` objects are the `Source` objects for the Unit Price and Unit Cost measures.

The `createCustomMeasure` method of the `MdmMeasureDimension` returns an `MdmMeasure` that has the name `MARKUP`, is a member of the root `MdmSchema`, has the calculation specified, and has the precedence value of 10.

The `selectValues` method of the `Source` for the `MdmMeasureDimension` returns a `Source` that specifies the identification `String` objects for each measure. For example, the ID of the custom measure is `Hidden..CUSTOM_MEASURES.MARKUP`. The example gets the short value description attributes for the Time and Product dimensions, and then gets the `Source` objects for those attributes.

The `prodRollup` object is the `Source` for a hierarchy of the `MdmPrimaryDimension` for the Product dimension, and `calendar` is a hierarchy of the `MdmPrimaryDimension` for the Time dimension. The `selectValue` method of `prodRollup` returns a `Source` that specifies one member of the Product hierarchy, and the `selectValues` method of `calendar` returns a `Source` that specifies three members of the Time hierarchy.

The `extract` method of `measDim` produces a `Source` that specifies the values of the `Source` objects that are the element values of `measDim`. The first `join` method provides `Source` objects that match the inputs of the `Source` produced by the `extract` method. The next two `join` methods add the short value description attribute for the Time dimension members and provide the input required by the attribute. The final two `join` methods do the same for the Product dimension members. For more information about `Source` objects and the inputs of a `Source`, see [Chapter 6, "Understanding Source Objects"](#).

Example 2-4 Creating a Custom Member of the MdmMeasureDimension

```
MdmSchema rootSchema = mdmMetadataProvider.getRootSchema();
MdmMeasureDimension mdmMeasDim = rootSchema.getMeasureDimension();
StringSource measDim = (StringSource) mdmMeasDim.getSource();

Source calculation = unitPrice.minus(unitCost);

MdmMeasure mdmMarkup = mdmMeasDim.createCustomMeasure("MARKUP",
                                                    rootSchema,
                                                    calculation,
                                                    10);

Source measDimSel = measDim.selectValues(new String[]
                                        {mdmMarkup.getValue(),
                                        mdmUnitPrice.getValue(),
                                        mdmUnitCost.getValue()});

Source timeShortDesc =
    mdmTimeDim.getShortValueDescriptionAttribute().getSource();
Source prodShortDesc =
    mdmProdDim.getShortValueDescriptionAttribute().getSource();

StringSource prodSel = prodRollup.selectValue("PRODUCT_ROLLUP::ITEM::13");
StringSource timeSel = calendar.selectValues(new String[]
                                            {"CALENDAR::MONTH::43",
                                             "CALENDAR::MONTH::44",
                                             "CALENDAR::MONTH::45"});

Source result = measDim.extract()
```

```
.join(measDimSel)
.join(timeShortDesc.join(timeSel))
.join(prodShortDesc.join(prodSel));
```

A Cursor for the result object has nine sets of values. Each set has the product member value and short value description, the time member value and short value description, the ID of the measure, and the measure value specified by the product and time members. The first set of values is the following:

```
PRODUCT_ROLLUP::ITEM::13, Envoy Standard, CALENDAR::MONTH::43, Jan-00,
Hidden..CUSTOM_MEASURES.MARKUP, 134.24
```

The following is a display of the values of a Cursor for result in a crosstab format that has only the description and measure values and that has column headings added.

```
Product: Envoy Standard
Month   Unit Cost Unit Price Markup
-----
Jan-00  2865.87   3000.11   134.24
Feb-00  2862.51   3008.91   146.40
Mar-00  2926.79   3142.99   216.20
```

Connecting to a Data Store

This chapter explains the procedure for connecting to a data store through the OLAP API.

This chapter includes the following topics:

- [Overview of the Connection Process](#)
- [Establishing a Connection](#)
- [Getting an Existing Connection](#)
- [Executing DML Commands Through the Connection](#)
- [Closing a Connection](#)

Overview of the Connection Process

When an application gains access to data through the OLAP API, it uses a connection provided by the Oracle implementation of the Java Database Connectivity (JDBC) API from Sun Microsystems. For information about using this JDBC implementation, see the *Oracle Database JDBC Developer's Guide and Reference*.

The Oracle JDBC classes that you use to establish a connection to Oracle OLAP are in the `classes12.jar` file. For information about getting the JDBC Java archive (jar) file, see [Appendix A, "Setting Up the Development Environment"](#).

Connection Steps

The procedure for connecting involves loading an Oracle JDBC driver, getting a connection through that driver, and creating two OLAP API objects that handle transactions and data transfer.

These steps are described in the topic "[Establishing a Connection](#)" on page 3-2.

Prerequisites for Connecting

Before attempting to make an OLAP API connection to an Oracle database, ensure that the following requirements are met:

- The Oracle Database instance is running and was installed with the OLAP option.
- The Oracle Database user ID that you are using for the connection has access to the relational schemas on which the data store is based.
- The Oracle JDBC and OLAP API jar files are on your application development computer and are accessible to the application code. For information about setting

up the required jar files, see [Appendix A, "Setting Up the Development Environment"](#).

Establishing a Connection

To make a connection, perform the following steps:

1. Load the JDBC driver for the connection.
2. Get a JDBC `OracleConnection` from the `DriverManager`.
3. Create a `TransactionProvider`.
4. Create a `DataProvider`.

These steps are explained in more detail in the rest of this topic.

Note that the `TransactionProvider` and `DataProvider` objects that you create in these steps are the ones that you use throughout your work with the data store. For example, when you create certain `Source` objects, you use methods of this `DataProvider` object.

Step 1: Load the JDBC Driver

The following line of code loads a JDBC driver and registers it with the JDBC `DriverManager`.

Example 3-1 Loading the JDBC Driver for a Connection

```
try
{
    Class.forName("oracle.jdbc.driver.OracleDriver");
}
catch(ClassNotFoundException e)
{
    System.out.println("Could not load the JDBC driver. " + e);
}
```

After the driver is loaded, you can use the `DriverManager` object to make a connection. For more information about loading Oracle JDBC drivers, see the *Oracle Database JDBC Developer's Guide and Reference*.

Step 2: Get a Connection from the DriverManager

The following code gets a JDBC `OracleConnection` object from the `DriverManager`.

Example 3-2 Getting a JDBC OracleConnection

```
String url = "jdbc:oracle:thin:@myhost:1521:orcl";
String user = "global";
String password = "global";
oracle.jdbc.OracleConnection conn = null;
try
{
    conn = (oracle.jdbc.OracleConnection)
        java.sql.DriverManager.getConnection(url, user, password);
}
catch(SQLException e)
{
```

```

        System.out.println("Connection attempt failed. " + e);
    }

```

This example connects the user `global`, who has the password `global`, to a database with the SID (system identifier) `orcl`. The connection is made through TCP/IP listener port 1521 of host `myhost`. The connection uses the Oracle JDBC thin driver.

There are many ways to specify your connection characteristics using the `getConnection` method. See the *Oracle Database JDBC Developer's Guide and Reference* for details.

After you have the `OracleConnection` object, you can create the required OLAP API objects, `TransactionProvider` and `DataProvider`.

Step 3: Create a `TransactionProvider`

`TransactionProvider` is an OLAP API interface that is implemented for Oracle OLAP by the `ExpressTransactionProvider` concrete class. In your code, you create an instance of `ExpressTransactionProvider`, as in the following example.

Example 3-3 *Creating a `TransactionProvider`*

```
ExpressTransactionProvider tp = new ExpressTransactionProvider();
```

A `TransactionProvider` is required for creating a `DataProvider`.

Step 4: Create a `DataProvider`

`DataProvider` is an OLAP API abstract class. The concrete class `ExpressDataProvider` extends `DataProvider`. The following lines of code create and initialize an `ExpressDataProvider`.

Example 3-4 *Creating a `DataProvider`*

```
ExpressDataProvider dp = new ExpressDataProvider(conn, tp);
try
{
    dp.initialize();
}
catch(SQLException e)
{
    System.out.println("Could not initialize the DataProvider. " + e);
}

```

A `DataProvider` is required for creating a `MetadataProvider`, which is described in [Chapter 4, "Discovering the Available Metadata"](#).

Getting an Existing Connection

To use the JDBC `OracleConnection` object after the connection has been established, you can call the `getConnection` method of your `ExpressDataProvider`. The following line of code calls the `getConnection` method of `dp`, which is an `ExpressDataProvider`.

Example 3-5 *Getting an Existing Connection*

```
oracle.jdbc.OracleConnection currentConn = dp.getConnection();
```

Executing DML Commands Through the Connection

Some applications depend on the run-time execution of Oracle OLAP data manipulation language (DML) commands or programs. DML commands and programs execute in an analytic workspace outside the context of MDM metadata, which is intrinsic to the OLAP API. Therefore, such commands and programs do not operate on MDM objects, such as an `MdmMeasure` or an `MdmDimension`. Instead, they operate on DML objects, such as a variable or a dimension. The MDM and DML contexts are related but distinct.

To execute DML commands or programs in an analytic workspace, create an OLAP API `SPLExecutor` object, specifying the JDBC `OracleConnection` object that you want to use. Note that the data manipulation language is sometimes referred to as a stored procedure language (SPL).

Example 3–6 creates and initializes an `SPLExecutor` object. The `conn` object is an `OracleConnection`. The `executeCommand` method of the `SPLExecutor` passes to Oracle OLAP a DML command that attaches an analytic workspace named `myworkspace`.

For the complete code for the following example, see the example programs available from the Overview of the *Oracle OLAP Java API Reference*.

Example 3–6 Executing DML Commands

```
SPLExecutor dmlExec = new SPLExecutor(conn);
try
{
    dmlExec.initialize();
}
catch(SQLException e)
{
    System.out.println("Cannot initialize the SPL executor. " + e);
}
String returnVal = dmlExec.executeCommand('aw attach myworkspace');
```

For information about using the DML, see the *Oracle OLAP DML Reference*. For more information about using an `SPLExecutor`, see the *Oracle OLAP Java API Reference*.

Closing a Connection

If you are finished using the OLAP API, but you want to continue working in your JDBC connection to the database, then use the `close` method of your `DataProvider` to release the OLAP API resources.

```
dp.close();    // dp is the DataProvider
```

When you have completed your work with the data store, use the `OracleConnection.close` method.

Example 3–7 Closing a Connection

```
try
{
    conn.close();    // conn is the OracleConnection
}
catch(SQLException e)
{
    System.out.println("Cannot close the connection. " + e);
}
```

Discovering the Available Metadata

This chapter explains the procedure for discovering the metadata in a data store through the OLAP API.

This chapter includes the following topics:

- [Overview of the Procedure for Discovering Metadata](#)
- [Creating an MdmMetadataProvider](#)
- [Getting the Root MdmSchema](#)
- [Getting the Contents of the Root MdmSchema](#)
- [Getting the Characteristics of Metadata Objects](#)
- [Getting the Source for a Metadata Object](#)
- [Sample Code for Discovering Metadata](#)

For the complete code of the examples in this chapter, see the example programs available from the Overview of the *Oracle OLAP Java API Reference*.

Overview of the Procedure for Discovering Metadata

The OLAP API provides access to a collection of Oracle data for which a database administrator has created OLAP Catalog metadata. This collection of data is the data store for the application. The API also provides the ability to create custom metadata objects and map relational table data to the metadata objects, and to create queries that use the data to which the custom objects are mapped.

Potentially, the data store includes all of the measure folders that were created by the database administrator in the OLAP Catalog. However, the scope of the data store that is visible when an application is running depends on the database privileges that apply to the user ID through which the connection was made. A user sees all of the measure folders (as `MdmSchema` objects) that the database administrator or the application created, but the user sees the measures and dimensions that are contained in those measure folders only if he or she has access rights to the relational tables to which the measures and dimensions are mapped.

MDM Metadata

When the database administrator created the OLAP Catalog metadata, the administrator created measures, dimensions, and other OLAP metadata objects by mapping them to columns in database tables or views. In the OLAP API, these objects are accessed as multidimensional metadata (MDM) objects, as described in [Chapter 2, "Understanding OLAP API Metadata"](#).

The mapping between the OLAP metadata objects and the MDM objects is automatically performed by Oracle OLAP. You can, however, discover the mapping of the MDM objects by using classes in the `oracle.olapi.metadata.mtm` package, as described in [Chapter 5, "Working with Metadata Mapping Objects"](#). You can also create your own custom MDM metadata objects and map them to database tables or views using MTM objects.

Purpose of Discovering the Metadata

The metadata objects in the data store help your application to make sense of the data. They provide a way for you to find out what data is available, how it is structured, and what its characteristics are.

Therefore, after connecting, your first step is to find out what metadata is available. Armed with this knowledge, you can present choices to the end user about what data should be selected or calculated and how it should be displayed.

Steps in Discovering the Metadata

Before investigating the metadata, your application must make a connection to Oracle OLAP, as described in [Chapter 3, "Connecting to a Data Store"](#). Then, your application might perform the following steps:

1. Create an `MdmMetadataProvider`.
2. Get the root `MdmSchema` from the `MdmMetadataProvider`.
3. Get the contents of the root `MdmSchema`, which include `MdmMeasure`, `MdmDimension`, `MdmMeasureDimension`, and `MdmSchema` objects. In addition, get the contents of any subschemas.
4. Get the components or related objects of each `MdmMeasure` and `MdmDimension`. For example, get the `MdmDimension` objects for each `MdmMeasure`, and for each `MdmDimension` get its `MdmHierarchy` objects.

The next four topics in this chapter describe these steps in detail.

Discovering Metadata and Making Queries

After your application discovers the metadata, it typically goes on to create queries for selecting, calculating, and otherwise manipulating the data. To work with data in these ways, you must get the `Source` objects from the MDM objects. These `Source` objects are referred to as primary `Source` objects. `Source` objects specify the data for querying.

This chapter focuses on the initial step of discovering the available metadata, but it also briefly mentions the step of getting a primary `Source` from a metadata object. Subsequent chapters of this guide explain how you work with primary `Source` objects and create queries based on them.

Creating an MdmMetadataProvider

An `MdmMetadataProvider` gives access to the metadata in a data store. It provides OLAP metadata objects, such as measures, dimensions, and measure folders, as corresponding MDM objects, such as `MdmMeasure`, `MdmDimension`, and `MdmSchema` objects.

Before you can create an `MdmMetadataProvider`, you must create a `DataProvider` as described in [Chapter 3, "Connecting to a Data Store"](#). [Example 4–1](#) creates an `MdmMetadataProvider`. In the example, `dp` is an `ExpressDataProvider`.

Example 4–1 Creating an `MdmMetadataProvider`

```
MdmMetadataProvider mp = null;
try
{
    mp = (MdmMetadataProvider) dp.getDefaultMetadataProvider();
}
catch (UnsupportedDatabaseException e)
{
    System.out.println("Cannot create the MDM metadata provider. " + e);
}
```

Getting the Root MdmSchema

Getting the root `MdmSchema` is the first step in exploring the metadata in your data store.

Function of the Root MdmSchema

The metadata objects that are accessible through an `MdmMetadataProvider` are organized in a tree-like structure, with the root `MdmSchema` at the top. Under the root `MdmSchema` are `MdmPrimaryDimension` objects and one or more `MdmSchema` objects, which are referred to as subschemas. In addition, if an `MdmMeasure` object does not belong to any subschema, then it is included under the root.

Subschemas have their own `MdmMeasure` and `MdmPrimaryDimension` objects. Optionally, they can have their own subschemas as well.

The root `MdmSchema` contains all of the `MdmPrimaryDimension` objects that are in the subschemas. Therefore, an `MdmPrimaryDimension` typically appears twice in the tree. It appears once under the root `MdmSchema` and again under the subschema. If an `MdmPrimaryDimension` does not belong to a subschema, then it is listed only under the root.

The starting point for discovering the available metadata objects is the root `MdmSchema`, which is the top of the tree. The following diagram illustrates an `MdmSchema` that has two subschemas and four `MdmPrimaryDimension` objects.

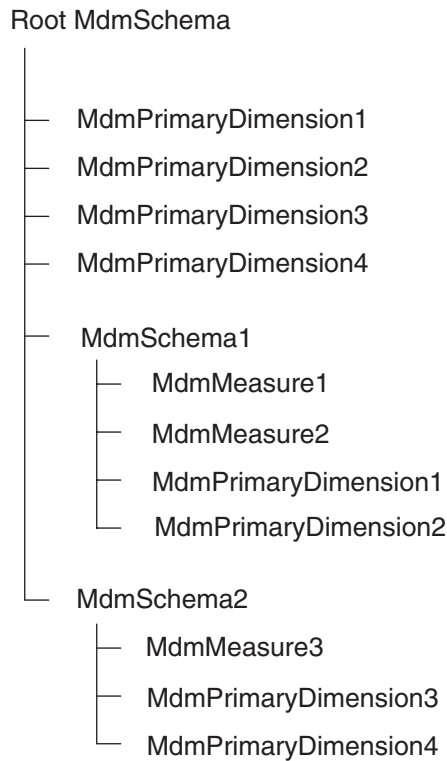
Figure 4–1 Root MdmSchema and Subschemas

In the OLAP Catalog, a database administrator arranges dimensions and measures under one or more top-level measure folders. When Oracle OLAP maps the measure folders to MdmSchema objects, it always creates the root MdmSchema over the MdmSchema objects for the top-level measure folders. Therefore, even if the database administrator creates only one measure folder, its corresponding MdmSchema is a subschema under the root.

For more information about MDM metadata objects and how they map to OLAP metadata objects, see [Chapter 2, "Understanding OLAP API Metadata"](#).

Calling the getRootSchema Method

The following code gets the root MdmSchema for mp, which is an MdmMetadataProvider.

Example 4–2 Getting the Root MdmSchema

```
MdmSchema rootSchema = mp.getRootSchema();
```

Getting the Contents of the Root MdmSchema

The root MdmSchema contains MdmPrimaryDimension objects, MdmSchema objects, and possibly MdmMeasure objects. In addition, the root MdmSchema has an MdmMeasureDimension that has a List of all of the MdmMeasure objects.

Getting the MdmDimension Objects in an MdmSchema

The following code gets a `List` of the `MdmPrimaryDimension` objects that are in `rootSchema`, which is the root `MdmSchema`. The `List` does not include the `MdmMeasureDimension`.

Example 4-3 Getting MdmDimension Objects

```
List dims = rootSchema.getDimensions();
```

Getting the Subschemas in an MdmSchema

The following code gets a `List` of `MdmSchema` objects that are in `rootSchema`.

Example 4-4 Getting Subschemas

```
List subSchemas = rootSchema.getSubSchemas();
```

Getting the Contents of Subschemas

For each `MdmSchema` that is under the root `MdmSchema`, you can call its `getMeasures`, `getDimensions`, and `getSubSchemas` methods. The procedures are the same as those for getting the contents of the root `MdmSchema`.

Getting the MdmMeasureDimension and Its Contents

[Example 4-5](#) gets the `MdmMeasureDimension` that is in the root `MdmSchema`. Use this method only on the root `MdmSchema`, because only the root `MdmSchema` has the `MdmMeasureDimension`. The example displays the names of the `MdmMeasure` objects that are contained by the `MdmMeasureDimension`.

Example 4-5 Getting the MdmMeasureDimension and Its Contents

```
MdmMeasureDimension mdmMeasureDim =
    (MdmMeasureDimension) rootSchema.getMeasureDimension();
List mdmMeasureDimMeasures = mdmMeasureDim.getMeasures();
Iterator mdmMeasureDimMeasuresItr = mdmMeasureDimMeasures.iterator();
MdmMeasure measure = null;
System.out.println("The measures in the MdmMeasureDimension are:");
while (mdmMeasureDimMeasuresItr.hasNext())
{
    measure = (MdmMeasure) mdmMeasureDimMeasuresItr.next();
    System.out.println("\t" + measure.getName());
}
```

Getting the Characteristics of Metadata Objects

Having discovered the list of `MdmMeasure` and `MdmDimension` objects, the next step in metadata discovery involves finding out the characteristics of those objects.

Getting the MdmDimension Objects for an MdmMeasure

A primary characteristic of an `MdmMeasure` is that it has related `MdmPrimaryDimension` objects. [Example 4-6](#) gets a `List` of `MdmPrimaryDimension` objects for `mdmUnits`, which is an `MdmMeasure`.

Example 4-6 Getting the Dimensions of an MdmMeasure

```
List dimsOfUnits = mdmUnits.getDimensions();
```

The `getMeasureInfo` method, which is in the [Example 4-9](#), shows one way to iterate through the `MdmPrimaryDimension` objects belonging to an `MdmMeasure`.

Getting the Related Objects for an MdmPrimaryDimension

An `MdmPrimaryDimension` has one or more component `MdmHierarchy` objects, which you can obtain by calling its `getHierarchies` method. That method returns a `List` of `MdmHierarchy` objects. If an `MdmHierarchy` is an `MdmLevelHierarchy`, then it has levels that you can obtain by calling its `getLevels` method.

[Example 4-7](#) demonstrates how you can get the `MdmHierarchy` objects for an `MdmPrimaryDimension`. The example displays the OLAP Catalog names of the `MdmHierarchy` objects.

Example 4-7 Getting the MdmHierarchy Components of an MdmPrimaryDimension

```
List mdmHiers = mdmPrimaryDim.getHierarchies();
Iterator mdmHiersItr = mdmHiers.iterator();
System.out.println("The MdmHierarchy components of " + mdmPrimaryDim.getName()
    + " are:");
while (mdmHiersItr.hasNext())
{
    MdmHierarchy mdmHier = (MdmHierarchy) mdmHiersItr.next();
    System.out.println("\t" + mdmHier.getName());
}
```

The `getDimInfo` method in [Example 4-9](#) shows one way to get the following metadata objects for an `MdmDimension`.

- Its concrete class.
- Its `MdmHierarchy` objects.
- Its default `MdmHierarchy` object.
- The `MdmAttribute` objects returned by its `getAttributes` method.
- Its parent, ancestors, level, and level depth attributes.

Methods are also available for obtaining other `MdmPrimaryDimension` characteristics. See the *Oracle OLAP Java API Reference* for descriptions of all of the methods of the MDM classes.

Getting the Source for a Metadata Object

A metadata object represents a set of data, but it does not provide the ability to create queries on that data. Its function is informational, recording the existence, structure, and characteristics of the data. It does not give access to the data values.

To access the data values for a metadata object, an application gets the `Source` object for that metadata object. A `Source` for a metadata object is called a primary `Source`.

To get the primary `Source` for a metadata object, an application calls the `getSource` method of that metadata object. For example, if an application needs to display the quantity of product units sold during the year 1999, then it must use the `getSource` method of the `MdmMeasure` for that data, which is `mdmUnits` in the following example.

Example 4–8 Getting a Primary Source for a Metadata Object

```
Source units = mdmUnits.getSource();
```

For more information about getting and working with primary Source objects, see [Chapter 6, "Understanding Source Objects"](#).

Sample Code for Discovering Metadata

The sample code that follows is a simple Java program called `SampleMetadataDiscoverer10g`. The program discovers the metadata objects that are under the root `MdmSchema` of a data store. The output of the program lists the names and related objects for the `MdmMeasure` and `MdmDimension` objects in the root `MdmSchema` and the `MdmSchema` subschema for the relational Global Schema for Documentation with OLAP Catalog Metadata.

After presenting the program code, this topic presents the output of the program when it is run against a data store that consists of the Global relational schema. In the OLAP metadata, the Global schema is represented as the `GLOBAL_CAT` measure folder. Through an OLAP API connection, the `GLOBAL_CAT` measure folder maps to an `MdmSchema` whose name is `GLOBAL_CAT`.

Code for the SampleMetadataDiscoverer10g Program

The program in [Example 4–9](#) gets the OLAP Catalog metadata objects that map to the tables and views of the Global relational schema. It passes the command line arguments that specify the server on which the Oracle Database instance is running and a user name and password to the `connectToDB` method of a `MyConnection10g` object, which establishes a connection to the database.

The code for the `MyConnection10g` is not shown here, but the procedure for connecting is described in [Chapter 3, "Connecting to a Data Store"](#). The complete code for the `MyConnection10g` and the `SampleMetadataDiscoverer10g` classes is available from the Overview of the *Oracle OLAP Java API Reference*.

Example 4–9 Discovering the OLAP Catalog Metadata

```
package globalExamples;

import oracle.express.olapi.data.full.ExpressDataProvider;
import oracle.olapi.metadata.mdm.*;
import oracle.olapi.data.source.Source;

import java.util.List;
import java.util.Iterator;

/**
 * Discovers the MDM metadata objects in the Global schema.
 * This file and the MyConnection10g.java file are available from the
 * Overview of the <I>Oracle OLAP Java API Reference</I>.
 */
public class SampleMetadataDiscoverer10g
{
/**
 * Constant to use to display less information about metadata objects.
 */
static final int TERSE = 0;
/**
 * Constant to use to display more information about metadata objects.
```

```
*/
static final int VERBOSE = 1;

private MdmSchema root = null;
private MdmPrimaryDimension mdmDim = null;

public SampleMetadataDiscoverer10g()
{
}

/**
 * Creates an object that makes a connection to an Oracle database
 * and gets MDM metadata objects.
 */
public void run(String[] args)
{
    // Connect through JDBC to an instance of an Oracle database
    // and get a DataProvider.
    MyConnection10g myConn = new MyConnection10g();
    ExpressDataProvider dp = myConn.connectToDB(args, TERSE);

    // Get the default MdmMetadataProvider from the DataProvider.
    MdmMetadataProvider mp = null;
    try
    {
        mp = (MdmMetadataProvider) dp.getDefaultMetadataProvider();
    }
    catch (Exception e)
    {
        System.out.println("Cannot create the MDM metadata provider." + e);
    }

    // Get metadata information about the root MdmSchema and its subschemas.
    try
    {
        root = mp.getRootSchema();
        System.out.println("The root MdmSchema is " + root.getName() + ".\n");
        getSchemaInfo(root, VERBOSE);
    }
    catch (Exception e)
    {
        System.out.println("Encountered exception. " + e);
    }

    // Get the Source for the dimension that was saved in getDimInfo.
    System.out.println("\nGetting the primary Source object for dimension " +
        mdmDim.getName() + ".");
    Source dimSource = mdmDim.getSource();
    System.out.println("Got the Source.");

    // Close the ExpressDataProvider and the connection.
    dp.close();
    System.out.println("\nClosed the DataProvider.");
    myConn.closeConnection();
    System.out.println("Closed the connection.");
}

/**
 * Gets information about an MdmSchema.
 */
```

```

public void getSchemaInfo(MdmSchema schema, int outputStyle)
{
    if (schema == root)
    {
        System.out.println("The MdmPrimaryDimension components of" +
            "the root schema are:");
    }
    else
    {
        System.out.println("  The MdmPrimaryDimension components of schema "
            + schema.getName() + " are:");
    }
    // Get the dimension information for the MdmSchema.
    MdmPrimaryDimension oneDim = null;
    int i = 1;
    try
    {
        List dims = schema.getDimensions();
        Iterator dimIter = dims.iterator();
        // Save the first dimension to use later for getting its Source.
        mdmDim = (MdmPrimaryDimension) dims.get(0);
        // Iterate through the list of MdmPrimaryDimension objects and get
        // information about each one.
        while (dimIter.hasNext())
        {
            oneDim = (MdmPrimaryDimension) dimIter.next();
            getDimInfo(i, oneDim, outputStyle);
            i++;
        }
    }
    catch (Exception e)
    {
        System.out.println("  Encountered exception. " + e);
    }

    // If the MdmSchema is the root MdmSchema, get the
    // MdmMeasureDimension and get its measures.
    MdmMeasure oneMeasure = null;
    MdmMeasureDimension mdmMeasureDim =
        (MdmMeasureDimension) schema.getMeasureDimension();
    if (mdmMeasureDim != null)
    {
        System.out.println("The measures of the MdmMeasureDimension are:");
        List mdmMeasures = mdmMeasureDim.getMeasures();
        Iterator mdmMeasuresIter = mdmMeasures.iterator();
        while (mdmMeasuresIter.hasNext())
        {
            oneMeasure = (MdmMeasure) mdmMeasuresIter.next();
            getMeasureInfo(oneMeasure, outputStyle);
            System.out.println(" ");
        }
    }

    // Get the measures from the MdmSchema.
    try
    {
        List mdmMeasures = schema.getMeasures();
        if (mdmMeasures.size() > 0)
        {
            Iterator mdmMeasuresIter = mdmMeasures.iterator();

```

```

        System.out.println("\n  The measures of schema " +
                           schema.getName() + " are:");
        while (mdmMeasuresIter.hasNext())
        {
            oneMeasure = (MdmMeasure) mdmMeasuresIter.next();
            getMeasureInfo(oneMeasure, outputStyle);
        }
    }
}
catch (Exception e)
{
    System.out.println("  Encountered exception. " + e);
}

// Get the subschema information for the MdmSchema.
MdmSchema oneSchema = null;
try
{
    List subSchemas = schema.getSubSchemas();
    Iterator subSchemaIter = subSchemas.iterator();
    while (subSchemaIter.hasNext())
    {
        oneSchema = (MdmSchema) subSchemaIter.next();
        // To get information on subschemas other than the Global
        // schema, GLOBAL_CAT, remove the if condition and call
        // the getSchemaInfo method.
        if (oneSchema.getName().equals("GLOBAL_CAT"))
            getSchemaInfo(oneSchema, TERSE);
    }
}
catch (Exception e)
{
    System.out.println("  Encountered exception. " + e);
}
}

/**
 * Gets information about an MdmMeasure.
 */
public void getMeasureInfo(MdmMeasure measure, int outputStyle)
{
    System.out.println("  " + measure.getName());
    if (outputStyle == VERBOSE)
    {
        // Get the dimensions of the MdmMeasure.
        try
        {
            List mDims = measure.getDimensions();
            Iterator mDimIter = mDims.iterator();
            System.out.println("  Its dimensions are: ");
            while (mDimIter.hasNext())
            {
                System.out.println("    " +
                                   ((MdmDimension) mDimIter.next()).getName());
            }
        }
        catch (Exception e)
        {
            System.out.println("  Encountered exception. " + e);
        }
    }
}

```

```

    }
}

/**
 * Gets information about an MdmDimension.
 */
public void getDimInfo(int count,
                      MdmPrimaryDimension dim,
                      int outputStyle)
{
    if (outputStyle == TERSE)
        System.out.println("  " + dim.getName());

    else if (outputStyle == VERBOSE)
    {
        System.out.println(count + ": MdmPrimaryDimension Name: " +
                           dim.getName());
        String description = dim.getDescription();
        if (description.length() > 0)
            System.out.println("  Description: " + dim.getDescription());
        // Determine the type of the MdmPrimaryDimension.
        try
        {
            if (dim instanceof MdmStandardDimension)
            {
                System.out.println("  It is an MdmStandardDimension.");
            }
            else if (dim instanceof MdmTimeDimension)
            {
                System.out.println("  It is an an MdmTimeDimension.");
            }
            else if (dim instanceof MdmMeasureDimension)
            {
                System.out.println("  It is an MdmMeasureDimension.");
            }
        }
        catch (Exception e)
        {
            System.out.println("  Encountered exception. " + e);
        }

        // Get the attributes of the MdmPrimaryDimension
        System.out.println("  Its attributes are:");
        try
        {
            List attributes = dim.getAttributes();
            Iterator attrIter = attributes.iterator();
            while (attrIter.hasNext())
            {
                System.out.println("  Attribute: " +
                                   ((MdmAttribute) attrIter.next()).getName());
            }
        }
        catch (Exception e)
        {
            System.out.println("  Encountered exception. " + e);
        }

        // Get the hierarchies of the MdmPrimaryDimension
        getHierInfo(dim);
    }
}

```

```

        System.out.println(" ");
    }
}

/**
 * Gets the MdmHierarchy components of an MdmPrimaryDimension.
 */
public void getHierInfo(MdmPrimaryDimension dim)
{
    List mdmHiers = dim.getHierarchies();
    Iterator mdmHiersItr = mdmHiers.iterator();
    MdmHierarchy mdmHier = null;
    MdmLevelHierarchy mdmLevelHier = null;
    boolean isLevelHierarchy = false;
    int i = 1;
    System.out.println("    The MdmHierarchy components of " +
        dim.getName() + " are:");
    while (mdmHiersItr.hasNext())
    {
        mdmHier = (MdmHierarchy) mdmHiersItr.next();
        System.out.println("    " + i + ": " + mdmHier.getName());
        if (mdmHier.isDefaultHierarchy())
        {
            System.out.println("    " + i + ": " + mdmHier.getName());
            " is the default MdmHierarchy of " + dim.getName() + ".";
        }
        if (mdmHier instanceof MdmLevelHierarchy)
        {
            mdmLevelHier = (MdmLevelHierarchy) mdmHier;
            System.out.println("        It is an MdmLevelHierarchy.");
            isLevelHierarchy = true;
        }
        else if (mdmHier instanceof MdmValueHierarchy)
        {
            System.out.println("        It is an MdmValueHierarchy");
        }
        System.out.println("        Its attributes are:");
        if (isLevelHierarchy)
        {
            System.out.println("            Level attribute: "
                + mdmLevelHier.getLevelAttribute().getName());
            System.out.println("            Level depth attribute: "
                + mdmLevelHier.getLevelDepthAttribute().getName());
        }
        System.out.println("            Parent attribute: " +
            mdmHier.getParentAttribute().getName());
        System.out.println("            Ancestors attribute: " +
            mdmHier.getAncestorsAttribute().getName());
        if (isLevelHierarchy)
            getLevelInfo(mdmLevelHier);
        i++;
    }
}

/**
 * Gets the MdmLevel components of an MdmLevelHierarchy.
 */
public void getLevelInfo(MdmLevelHierarchy mdmHier)
{
    List mdmLevels = mdmHier.getLevels();

```



```

        Iterator mdmLevelsItr = mdmLevels.iterator();
        System.out.println("        Its levels are:");
        while (mdmLevelsItr.hasNext()) {
            MdmLevel mdmLevel = (MdmLevel) mdmLevelsItr.next();
            System.out.println("        " + mdmLevel.getName());
        }
    }

    /**
     * Creates a new SampleMetadataDiscoverer10g object and calls its
     * run method.
     */
    public static void main(String[] args)
    {
        new SampleMetadataDiscoverer().run(args);
    }
}

```

Output from the SampleMetadataDiscoverer10g Program

The output from the sample program consists of text lines produced by Java statements such as the following one.

```
System.out.println("The root MdmSchema is " + root.getName() + ".\n");
```

When the program is run on the Global Schema for Documentation with OLAP Catalog Metadata, the output includes the following items:

- The name of the root MdmSchema, which is ROOT.
- The names and other information for the MdmPrimaryDimension objects in the root MdmSchema.
- The measures in the MdmMeasureDimension.
- The dimensions and measures of the GLOBAL_CAT MdmSchema.

Because the GLOBAL_CAT MdmSchema is the only subschema under the root MdmSchema, its MdmPrimaryDimension objects are identical to those in the root.

- Two lines that indicate that the code got the primary Source for an MdmPrimaryDimension.

Here is the output. To conserve space, some blank lines have been omitted.

```
The root MdmSchema is ROOT.
```

```
The MdmPrimaryDimension components of the root schema are:
```

```
1: MdmPrimaryDimension Name: CHANNEL
```

```
It is an MdmStandardDimension.
```

```
Its attributes are:
```

```
Attribute: Long_Description
```

```
Attribute: Short_Description
```

```
The MdmHierarchy components of CHANNEL are:
```

```
1: CHANNEL_ROLLUP
```

```
CHANNEL_ROLLUP is the default MdmHierarchy of CHANNEL.
```

```
It is an MdmLevelHierarchy.
```

```
Its attributes are:
```

```
Level attribute: D_GLOBAL.CHANNELLEVEL_ATTRIBUTE
```

```
Level depth attribute: D_GLOBAL.CHANNELLEVELDEPTH_ATTRIBUTE
```

```
Parent attribute: D_GLOBAL.CHANNELPARENT_ATTRIBUTE
```

```
Ancestors attribute: D_GLOBAL.CHANNELANCESTORS_ATTRIBUTE
```

Its levels are:
ALL_CHANNELS
CHANNEL

2: MdmPrimaryDimension Name: CUSTOMER

It is an MdmStandardDimension.

Its attributes are:

Attribute: Long_Description

Attribute: Short_Description

The MdmHierarchy components of CUSTOMER are:

1: MARKET_ROLLUP

It is an MdmLevelHierarchy.

Its attributes are:

Level attribute: D_GLOBAL.CUSTOMERLEVEL_ATTRIBUTE

Level depth attribute: D_GLOBAL.CUSTOMERLEVELDEPTH_ATTRIBUTE

Parent attribute: D_GLOBAL.CUSTOMERPARENT_ATTRIBUTE

Ancestors attribute: D_GLOBAL.CUSTOMERANCESTORS_ATTRIBUTE

Its levels are:

TOTAL_MARKET

MARKET_SEGMENT

ACCOUNT

SHIP_TO

2: SHIPMENTS_ROLLUP

SHIPMENTS_ROLLUP is the default MdmHierarchy of CUSTOMER.

It is an MdmLevelHierarchy.

Its attributes are:

Level attribute: D_GLOBAL.CUSTOMERLEVEL_ATTRIBUTE

Level depth attribute: D_GLOBAL.CUSTOMERLEVELDEPTH_ATTRIBUTE

Parent attribute: D_GLOBAL.CUSTOMERPARENT_ATTRIBUTE

Ancestors attribute: D_GLOBAL.CUSTOMERANCESTORS_ATTRIBUTE

Its levels are:

ALL_CUSTOMERS

REGION

WAREHOUSE

SHIP_TO

3: MdmPrimaryDimension Name: PRODUCT

It is an MdmStandardDimension.

Its attributes are:

Attribute: Long_Description

Attribute: Package

Attribute: Short_Description

The MdmHierarchy components of PRODUCT are:

1: PRODUCT_ROLLUP

PRODUCT_ROLLUP is the default MdmHierarchy of PRODUCT.

It is an MdmLevelHierarchy.

Its attributes are:

Level attribute: D_GLOBAL.PRODUCTLEVEL_ATTRIBUTE

Level depth attribute: D_GLOBAL.PRODUCTLEVELDEPTH_ATTRIBUTE

Parent attribute: D_GLOBAL.PRODUCTPARENT_ATTRIBUTE

Ancestors attribute: D_GLOBAL.PRODUCTANCESTORS_ATTRIBUTE

Its levels are:

TOTAL_PRODUCT

CLASS

FAMILY

ITEM

4: MdmPrimaryDimension Name: TIME

It is an an MdmTimeDimension.

Its attributes are:

```
Attribute: End_Date
Attribute: Long_Description
Attribute: Short_Description
Attribute: Time_Span
The MdmHierarchy components of TIME are:
1: CALENDAR
   CALENDAR is the default MdmHierarchy of TIME.
   It is an MdmLevelHierarchy.
   Its attributes are:
   Level attribute: D_GLOBAL.TIMELEVEL_ATTRIBUTE
   Level depth attribute: D_GLOBAL.TIMELEVELDEPTH_ATTRIBUTE
   Parent attribute: D_GLOBAL.TIMEPARENT_ATTRIBUTE
   Ancestors attribute: D_GLOBAL.TIMEANCESTORS_ATTRIBUTE
   Its levels are:
   YEAR
   QUARTER
   MONTH

The measures of the MdmMeasureDimension are:
UNIT_COST
Its dimensions are:
PRODUCT
TIME

UNIT_PRICE
Its dimensions are:
PRODUCT
TIME

UNITS
Its dimensions are:
CHANNEL
CUSTOMER
PRODUCT
TIME

Schema: GLOBAL_CAT
The MdmPrimaryDimension components of schema GLOBAL_CAT are:
CHANNEL
CUSTOMER
PRODUCT
TIME

The measures of schema GLOBAL_CAT are:
UNITS
UNIT_COST
UNIT_PRICE

Getting the primary Source object for dimension CHANNEL.
Got the Source.

Closed the DataProvider.
Closed the connection.
```

Working with Metadata Mapping Objects

The objects in the MDM model, which is described in Chapter 2, are based on relational tables and views in the data store. Metadata mapping (MTM) objects provide the information that maps the MDM objects to the relational tables and views on which the MDM objects are based. MTM objects are instances of the classes in the `oracle.olapi.metadata.mtm` package.

Application developers who have extensive experience with the OLAP API and with SQL can investigate, and in some cases create, objects from the MTM classes. For example, they might want to investigate MTM objects in order to discover the tables and columns to which particular MDM objects are mapped. Or they might want to create new objects in order to implement custom MDM objects, such as an `MdmMeasure`.

This chapter briefly describes the MTM objects, explains key concepts required for understanding them, and provides simple examples of how they can be used. The chapter has the following sections:

- [Overview of the MTM Classes](#)
- [Discovering the Columns Mapped To an MdmSource](#)
- [Creating a Custom Measure](#)
- [Understanding Solved and Unsolved Data](#)

For detailed information about the MTM classes, see the *Oracle OLAP Java API Reference*. For the complete code for the examples in this chapter, see the example programs available from the Overview of the *Oracle OLAP Java API Reference*.

Overview of the MTM Classes

When an application developer uses `Source` objects to specify a query and `Cursor` objects to execute it, Oracle OLAP first identifies the `MdmSource` objects that correspond to the `Source` objects, and then identifies the `MtmSourceMap` objects that correspond to those `MdmSource` objects. An `MtmSourceMap` object maps the relationship between an `MdmSource` and the underlying SQL tables and expressions on which the `MdmSource` is based.

Oracle OLAP must identify the underlying SQL tables and expressions, because it must generate a SQL `SELECT` statement for every `MdmSource` that is referenced in an OLAP API query. The `SELECT` statements are constructed by the SQL generator component of Oracle OLAP.

SELECT Statements for MdmSource Objects

The SQL generator tailors a SQL statement to the subclass of `MdmSource` for which it is generating the SQL code.

- For an `MdmSubDimension`, the SQL statement is based on an `MtmDimensionMap`. The code includes the following three parts, one on each line.

```
SELECT select-list-expression
FROM source-table
ORDER BY expression
```

- For an `MdmMeasure`, the SQL statement is based on an `MtmMeasureMap`. The code includes the following two parts, one on each line.

```
SELECT select-list-expression
FROM source-table
```

- An `MdmAttribute` does not have its own SQL statement. An `MdmAttribute` is associated with an `MdmDimension`, and it is based on the table or tables to which the `MdmDimension` is mapped. The columns for the `MdmAttribute` are part of the *select-list-expression* for the SELECT statement on which the `MdmDimension` is based. An `MtmAttributeMap` stores information about those columns.

An `MdmDimensionMap`, `MdmMeasureMap`, or `MdmAttributeMap` references the following MTM objects, which hold information about the parts of the generated SQL statement:

- An `MtmExpression`, which identifies an expression that the SQL generator can use as the *select-list-expression*.
- An `MtmTabularSource`, which identifies a logical table that the SQL generator can use as the *source-table* in the FROM clause. A *source-table* can be a table or view, a SELECT statement, or the join of a pair of tables.
- An `MtmDimensionOrderSpecification`, which holds information that the SQL generator can use to construct the *expression* for the ORDER BY clause of the SELECT statement for an `MdmDimension`.

For `MdmMeasure` objects, the SQL generator also uses the following MTM objects:

- `MtmBaseCube` objects, which record the dimensionality of the `MdmMeasure` objects for one set of the dimension hierarchies of an `MtmPartitionedCube`.
- `MtmCubeDimensionality` objects, which store information about the fact table and dimension tables that must be joined to specify the data of an `MdmMeasure`. An `MtmBaseCube` has a set of `MtmCubeDimensionality` objects, one for each dimension of the measures of the cube.

Purpose of MTM Objects

Instances of the classes in the MTM package provide the information that the SQL generator needs to construct SELECT statements that implement OLAP API queries. The information is recorded in the form of MTM objects, such as `MtmExpression`, `MtmTabularSource`, and `MtmCube`.

As an application developer, you can interrogate MTM objects to discover the underlying relational tables and expressions. In some cases, you can use the information that you have discovered to create new `MdmSource` objects.

Measures, Cubes, and Hierarchies

For mapping purposes, every `MdmMeasure` belongs to a cube, and all of the `MdmMeasure` objects in a cube have the same dimensionality. That is, the values of the measures are specified by elements of the same set of `MdmDimension` objects. Thus, when you know the cube to which a measure belongs, you also know its dimensionality. From the point of view of mapping, the MTM model only has to record the dimensionality once for all the measures in a cube.

Dimensions can have multiple hierarchies, and the underlying data can be different for each hierarchy. Therefore, the MTM model emphasizes hierarchy mappings, which are more specific, rather than dimension mappings.

The MTM model also considers the fact that if a cube is made up of dimensions with multiple hierarchies, then the data can be different for each combination of hierarchies. Therefore, such a cube is partitioned into base cubes, each of which represents one hierarchy combination.

For example, the OLAP Catalog has a cube for the UNITS measure and its four dimensions, which are TIME, PRODUCTS, CHANNEL, and CUSTOMER. CUSTOMER has two hierarchies, MARKET_ROLLUP and SHIPMENTS_ROLLUP. The other three dimensions each have only one hierarchy, which are CALENDAR, PRODUCT_ROLLUP, and CHANNEL_ROLLUP. The following are the possible hierarchy combinations for the measures.

CALENDAR, PRODUCT_ROLLUP, CHANNEL_ROLLUP, MARKET_ROLLUP

CALENDAR, PRODUCT_ROLLUP, CHANNEL_ROLLUP, SHIPMENTS_ROLLUP

The `MtmPartitionedCube` for that cube therefore has two `MtmBaseCube` objects.

For all of these reasons, the mappings that are recorded by MTM objects are organized by cube and hierarchy, rather than by measure and dimension.

Discovering the Columns Mapped To an MdmSource

Ordinarily, neither an end-user nor an application developer needs to know the names of the relational columns to which an `MdmSource` is mapped. However, sometimes this information can be useful. For example, an application developer might want to ask a database administrator (DBA) to change a particular value in a dimension or might want to identify an existing column so that the developer can map a new custom metadata object to it. To discover the columns to which an `MdmSource` is mapped, you use instances of the concrete subclasses of the `MtmObject` class.

To identify the columns to which an `MdmSource` is mapped, you first get the `MtmSourceMap` for the `MdmSource`, and then from it you get the `MtmTabularSource`. From the `MtmTabularSource`, you get the `MtmColumnExpression` objects that represent the columns.

Of course, not all `MdmSource` objects have a specific column that can be mapped. An `MdmSource` that is mapped to a specific column has an `MtmExpression` that is implemented as an `MtmColumnExpression`. The `MtmExpression` cannot be an `MtmCustomExpression` or `MtmLiteralExpression`, because these objects are not based on a specific column. You should be familiar with the data and metadata with which you are working, so that you are not attempting to find specific columns for `MdmSource` objects that are derived or otherwise specified.

Example of Getting the Columns Mapped To an MdmLevelHierarchy

In [Example 5-1](#), `mdmProdHier` is an `MdmLevelHierarchy` that represents the default hierarchy of the `PRODUCT` dimension. The example gets the `MtmLevelHierarchyMap` for the `MdmLevelHierarchy`, gets the `MtmRdbmsTableOrView` that represents the relational table to which the dimension is mapped, and then gets the `MtmColumnExpression` objects that represent the columns of the table.

Example 5-1 Getting the Columns for an MtmLevelHierarchyMap

```
MtmLevelHierarchyMap mtmProdHierMap =
    (MtmLevelHierarchyMap) mdmProdHier.getLevelHierarchyMap();
MtmRdbmsTableOrView mtmRdbmsTableOrView =
    (MtmRdbmsTableOrView) mtmProdHierMap.getTable();
System.out.println("The name of the table is "
    + mtmRdbmsTableOrView.getName());
List mdmProdColumns = mtmRdbmsTableOrView.getColumns();
Iterator mdmProdColItr = mdmProdColumns.iterator();
System.out.println("Its columns are:");
while (mdmProdColItr.hasNext())
{
    MtmColumnExpression mtmColExp = (MtmColumnExpression) mdmProdColItr.next();
    System.out.println(mtmColExp.getColumnName());
}
```

The output of the example is the following:

```
The name of the table is GLOBAL.PRODUCT_DIM
Its columns are:
TOTAL_PRODUCT_ID
CLASS_ID
FAMILY_ID
ITEM_ID
CLASS_DSC
FAMILY_DSC
ITEM_DSC
TOTAL_PRODUCT_DSC
ITEM_PACKAGE_ID
```

Example of Getting the Columns Mapped To an MdmLevel

In [Example 5-2](#), the `mdmShipToLevel` object is the `MdmLevel` that represents the `SHIP_TO` level of the default `MdmLevelHierarchy` of the `CUSTOMER` dimension. The example gets the `MtmColumnExpression` object that represents the column to which the `MdmLevel` is mapped and then gets the table that the column is in.

Example 5-2 Getting the Column Mapped To an MdmLevel

```
MtmLevelMap mtmShipToLevelMap = mdmShipToLevel.getLevelMap();
MtmColumnExpression mtmShipToColumnExp = (MtmColumnExpression)
    mtmShipToLevelMap.getLevelExpression();
String shipToLevelColumnName = mtmShipToColumnExp.getColumnName();
System.out.println(shipToLevelColumnName);

MtmRdbmsTableOrView mtmTableWithShipTo = (MtmRdbmsTableOrView)
    mtmShipToColumnExp.getTable();
System.out.println(mtmTableWithShipTo.getName());
```

The example displays the following:

```
SHIP_TO_ID
GLOBAL.CUSTOMER_DIM
```

Example of Getting the Columns Mapped To an MdmMeasure

In [Example 5-3](#), `mdmUnits` is an `MdmMeasure` that represents the `UNITS` measure. The example gets the `MtmMeasureMap` for the `MdmMeasure`, gets the `MtmPartitionedCube` that represents the cube to which the measure belongs, and gets the base cubes of the `MtmPartitionedCube`. The base cubes are all instances of `MtmUnsolvedCube`.

For the first base cube, the example gets the `MtmRdbmsTableOrView` that represents the relational table to which the dimension is mapped, which is the `GLOBAL.UNITS_HISTORY_FACT` table, and then gets the `MtmColumnExpression` objects that represent the columns of the table.

The other base cube of the partitioned cube represents the other combination of dimension hierarchies for the cube. All of the base cubes are mapped to the same table.

Example 5-3 Getting the Columns For an MdmMeasure

```
MtmMeasureMap mtmMeasureMap = mdmUnits.getMeasureMap();
MtmPartitionedCube mtmPCube = (MtmPartitionedCube) mtmMeasureMap.getCube();
List baseCubes = mtmPCube.getBaseCubes();
MtmUnsolvedCube mtmFirstBaseCube = (MtmUnsolvedCube) baseCubes.get(0);
MtmRdbmsTableOrView mtmRdbmsTableorView =
    (MtmRdbmsTableOrView) mtmFirstBaseCube.getTable();
System.out.println("The name of the table is " +
    mtmRdbmsTableorView.getName());
List columns = mtmRdbmsTableorView.getColumns();
Iterator colItr = columns.iterator();
System.out.println("Its columns are:")
while (colItr.hasNext())
{
    MtmColumnExpression mtmColExpr = (MtmColumnExpression) colItr.next();
    System.out.println(mtmColExpr.getColumnName());
}
```

The example displays the following:

```
The name of the table is GLOBAL.UNITS_DETAIL_FACT
Its columns are:
CHANNEL_ID
SHIP_TO_ID
ITEM_ID
MONTH_ID
UNITS
```

Creating a Custom Measure

Using the MTM mapping objects, you can create a custom metadata objects, such as an `MdmMeasure`, that exists only for the life of your `MdmMetadataProvider`. A custom `MdmMeasure` must be assigned to an existing `MtmCube`.

To create a custom measure, you start with an existing `MdmMeasure` that has the dimensionality that you want your custom `MdmMeasure` to have. Oracle OLAP assigns the new `MdmMeasure` to the `MtmCube` to which the existing `MdmMeasure` belongs, and creates it within the scope of your current `MdmMetadataProvider`.

Complete the following steps to create the custom measure:

1. Call the `getMeasureMap` method of the existing `MdmMeasure`, which returns the `MtmMeasureMap` for the `MdmMeasure`.
2. Call the `getCube` method of the `MtmMeasureMap`, which returns the `MtmPartitionedCube` for the `MtmMeasureMap`.
3. Call the `getMdmCustomObjectFactory` method of your `MdmMetadataProvider`, which returns an `MdmCustomObjectFactory`.
4. Call a method of the `MdmCustomObjectFactory` that creates a new `MtmExpression`.
5. Call a method of the `MdmCustomObjectFactory` that accepts the `MtmCube` and `MtmExpression` as parameters and returns a new custom `MdmMeasure`.

Example 5-4 demonstrates these steps. It creates a custom `MdmMeasure` that is based on the RDBMS column to which an existing `MdmMeasure` is mapped. In the example, the existing `MdmMeasure` is `mdmUnitPrice` and `mp` is the `MdmMetadataProvider`. The `MdmMeasure` is based on the `UNIT_PRICE` column of the `PRICE_AND_COST_HISTORY_FACT` table of the relational `Global` schema.

Example 5-4 Creating a Custom Measure

```
MtmMeasureMap mtmUnitPriceMap = mdmUnitPrice.getMeasureMap();
MtmPartitionedCube mtmUnitPricePartCube = (MtmPartitionedCube)
                                         mtmUnitPriceMap.getCube();
MdmCustomObjectFactory mdmCustObjFactory = mp.getMdmCustomObjectFactory();
FundamentalMetadataProvider fdp = dp.getFundamentalMetadataProvider();
FundamentalMetadataObject numberFMO = fdp.getNumberDataType();
MtmCustomExpression mtmCustExp =
    mdmCustObjFactory.createCustomExpression("UNIT_PRICE - UNIT_COST",
                                           numberFMO);
MdmMeasure mdmCustMeasure =
    mdmCustObjFactory.createNumericMeasure("MARKUP",
                                         mtmUnitPricePartCube,
                                         mtmCustExp);
```

Understanding Solved and Unsolved Data

The way in which an `MdmSource` is mapped by MTM objects depends on the way its underlying data is specified (the data might be solved or unsolved) as well as the form in which the data is aggregated (grouping set, rollup, or embedded totals form). An understanding of these storage and aggregation concepts can be useful when you peruse the MTM classes. Classes such as `MtmSolvedETCubeDimensionality` and `MtmUnsolvedLevelHierarchyMap` encapsulate the storage and aggregation types.

Solved Versus Unsolved Cubes and Hierarchies

Typically, the data that is analyzed using the OLAP API is structured hierarchically. Detailed (leaf-level) data is at the lowest level of the hierarchy, and aggregate data is at higher levels of the hierarchy. A hierarchy is one of two types:

- A level hierarchy, in which each element belongs to a level and the parent-child relationships are organized by level. A level-based hierarchy can have up to 31 levels.

- A value hierarchy, in which each element participates in parent-child relationships but there are no levels in the logical organization. (However, in the MTM model, a logical value hierarchy is stored in a level-based form.)

The detail data is ordinarily specified by a DBA in relational tables, materialized views, or an analytic workspace. However, the aggregate data might, or might not, be specified by the DBA. Aggregate data that is not specified by the DBA must be calculated by Oracle OLAP.

If all the data for a cube is specified by the DBA, then the cube is considered to be **solved**. If some or all of the aggregate data must be calculated by Oracle OLAP, then the cube is **unsolved**.

Note that the data for a solved cube is not necessarily stored in the database. It might be specified by the DBA as a materialized view, which is calculated when necessary. The distinction between solved and unsolved cubes rests on who specifies the data: the DBA, or Oracle OLAP.

It is not only cubes that can be either solved or unsolved. Hierarchies can be solved or unsolved as well. If all of the elements of a hierarchy, both aggregate and detailed, exist in a single table or view, then the hierarchy is solved. If some or all of the aggregate elements must be collected by Oracle OLAP from separate tables, then the hierarchy is unsolved.

Aggregation Forms for Cubes

There are three possible forms in which data for a cube can be aggregated. For a solved cube, the DBA specified the method of aggregation, so the SQL statement that is constructed by the SQL generator does not have to reflect the aggregation form. However, for an unsolved cube, the Oracle OLAP SQL generator constructs a SQL statement that is appropriate to the aggregation form.

The following forms are supported. Each is described in terms of a SQL statement, though it might be specified by a DBA for a solved cube or by the SQL generator for an unsolved cube.

- **Grouping set aggregation form.** The SQL statement uses the `GROUP BY GROUPING SETS` syntax to aggregate the data for each level combination. The select list includes all of the level expressions as well as a `GROUPING_ID` expression for each hierarchy.
- **Rollup aggregation form.** The SQL statement uses the `GROUP BY ROLLUP` syntax to aggregate the data for each level combination. The select list includes all of the level expressions as well as a `GROUPING_ID` expression for each hierarchy.
- **ET aggregation form.** The SQL statement uses the `GROUP BY ROLLUP` syntax to aggregate the data for each level combination. However, only the ET and `GROUPING_ID` expression for each hierarchy are placed in the `SELECT` list.

The SQL expressions for the three aggregation forms are described in more detail in the rest of this section. For information about `GROUPING_ID` expressions, ET expressions, and types of aggregation, see the *Oracle OLAP Application Developer's Guide*.

Aggregation for Unsolved Cubes

Using the aggregation form for a given cube, the SQL generator constructs an appropriate SQL statement. (Note that the `getAggregationForm` method of an `MtmUnsolvedCube` returns its aggregation form.)

In all cases, the SQL statement aggregates the higher-level values from the detailed level (leaf-level) data. The statement has the following structure.

```
SELECT SUM(measure1), SUM(measure2), ..., SUM(measureN), dimension-keys
FROM fact-table, dimension-tables
WHERE join-condition
GROUP BY group-by-clause
```

For example, assume a single hierarchy with three levels: Y as the top level, Q as the middle level, and M as the bottom level. The GROUP BY clause is one of the following, depending on the aggregation form:

GROUP BY clause for grouping set aggregation:

```
GROUP BY GROUPING SETS((Y), (Q), (M))
```

GROUP BY clause for rollup aggregation:

```
GROUP BY Y, ROLLUP(Q, M)
```

GROUP BY clause for ET aggregation:

```
GROUP BY Y, ROLLUP(Q, M)
```

Using the same example, the *dimension-keys* component of the select list is one of the following, depending on the aggregation form:

***dimension-keys* for grouping set aggregation:**

```
SELECT Y, Q, M, GROUPING_ID(Y, Q, M)
```

***dimension-keys* for rollup aggregation:**

```
SELECT Y, Q, M, GROUPING_ID(Y, Q, M)
```

***dimension-keys* for ET aggregation:**

```
SELECT
  (CASE GROUPING_ID(Y, Q, M)
   WHEN 3 THEN Y
   WHEN 1 THEN Q
   ELSE M
   END) et_value,
  GROUPING_ID(Y, Q, M)
```

In general, for grouping set or rollup form, the *dimension-keys* component is made up of one expression for each level and one GROUPING ID expression. For ET form, the *dimension-keys* component is made up of an ET expression and a GROUPING ID expression.

Note that, in all cases, the *join-condition* in the generated SQL statement is determined by the *MtmUnsolvedCubeDimensionality* object that is associated with the *MtmUnsolvedCube*.

Aggregation for Solved Cubes

All of the values, both detail and aggregate, for a solved cube are explicitly specified by a DBA. Therefore, the SELECT statement that is generated by the Oracle OLAP SQL generator is relatively simple, and it has the same structure for all aggregation forms. Using the same example, the SELECT statement would be the following.

```
SELECT Y, Q, M, dimension-keys
FROM source-table
```

The *dimension-keys* component has the same make up as it does for unsolved cubes, varying by the aggregation form that the DBA used.

The DBA specifies the aggregation form for a solved cube when he or she is setting up metadata using Oracle Enterprise Manager or the SQL procedures provided by Oracle for working with the OLAP Catalog.

The DBA specifies one of the following two storage types:

- **ET (Embedded Totals).** The fact table for the cube includes all of the aggregated values for the associated measures. Therefore, materialized views are not required. DBAs can create cubes with the ET storage type when they use the SQL procedures for working with the OLAP Catalog.
- **Lowest Level.** The fact table for the cube includes only the detailed (leaf-level) data. Aggregated values must be supplied using materialized views. When DBAs create cubes using the OLAP Management tool in Oracle Enterprise Manager, the cubes are created with lowest level storage type. Using a different tool, the DBA can specify one of the following forms of materialized view for aggregating data:
 - **Grouping Set form,** in which all the hierarchy combinations are in a single materialized view. This form is created when the DBA uses the DBMS_ODM package procedures.
 - **Rolled Up form,** in which there is a separate materialized view for each hierarchy combination. This form is created when the DBA uses the OLAP Summary Adviser in Oracle Enterprise Manager.

Thus, there are three aggregation forms, which correspond to the following three concrete subclasses of the `MtmSolvedCubeDimensionality` class.

- `MtmSolvedETCubeDimensionality`
- `MtmSolvedGroupingSetCubeDimensionality`
- `MtmSolvedRollupCubeDimensionality`

A term that recurs in the methods of the MTM classes is `GID`, which stands for Grouping ID. It refers to the `GID` column of the fact table for a cube. The `GID` column, which is derived from the level columns in the fact table, identifies the level associated with each value in a hierarchy. The values of a `GID` column are calculated by assigning a zero to each non-null value and a one to each null value in the level columns. The resulting binary number is the value of the `GID`. Hierarchy values that have the same `GID` are in the same level.

For more information about storage types, aggregation forms, and `GID` columns, see the *Oracle OLAP Application Developer's Guide*.

Solve Specifications for Unsolved Cubes

In addition to the aggregation form, an `MtmUnsolvedCube` has an `MtmSolveSpecification`, which records the SQL operation that Oracle performs when it aggregates the measure data specified by a dimension, and the order in which Oracle aggregates the dimensions of the measure. An `MtmAggregationSpecification`, which is a subclass of `MtmSolveSpecification`, has one or more `MtmAggregationStep` objects.

An `MtmAggregationStep` specifies the SQL function and other aspects of operations to perform when Oracle aggregates the values of the measures of an `MtmUnsolvedCube` for the dimension hierarchies that of the `MtmDimensionMap`

objects of the `MtmAggregationStep`. The `MtmDimensionMap` objects of an `MtmUnsolvedCube` are always instances of `MtmUnsolvedLevelHierarchyMap`.

Each `MtmUnsolvedLevelHierarchyMap` of the `MtmUnsolvedCube` is associated with one and only one `MtmAggregationStep`. An `MtmAggregationStep` can specify the aggregation operations for one or more of the `MtmUnsolvedLevelHierarchyMap` objects.

The default aggregation function is `SUM`. For an `MtmSimpleAggregationStep`, you can specify other SQL group functions or your own function. You can create a simple aggregation step or other types of aggregation steps with methods of an `MtmObjectFactory`, which you get from your `MdmMetadataProvider`.

The other types of aggregation steps are `MtmFirstLastAggregationStep`, `MtmWeightedAverageStep`, and `MtmNoAggregationStep`. An `MtmFirstLastAggregationStep` represents an aggregation that uses the `SUM` function and uses the measure data specified by the first or last child element of the current parent element as the aggregate measure value for the parent element. An `MtmWeightedAverageStep` specifies the `AVG` function with a weighting factor applied to the aggregation. An `MtmNoAggregationStep` specifies that no aggregation occur for the dimension hierarchy or hierarchies.

Understanding Source Objects

This chapter introduces `Source` objects, which you use to specify a query. With a `Source`, you specify the data that you want to retrieve from the data store and the analytical or other operations that you want to perform on the data. [Chapter 7, "Making Queries Using Source Methods"](#), provides examples of using `Source` objects. Using `Template` objects to make modifiable queries is discussed in [Chapter 11, "Creating Dynamic Queries"](#).

This chapter includes the following topics:

- [Overview of Source Objects](#)
- [Kinds of Source Objects](#)
- [Characteristics of Source Objects](#)
- [Inputs and Outputs of a Source](#)
- [Describing Parameterized Source Objects](#)
- [Model Objects and Source Objects](#)

For the complete code for most of the examples in this chapter, see the example programs available from the Overview of the *Oracle OLAP Java API Reference*.

Overview of Source Objects

After you have used the classes in the `oracle.olapi.metadata.mdm` package to get `MdmSource` objects that represent measures and dimensions in the OLAP Catalog, you can get `Source` objects from them. You can also create other `Source` objects with methods of a `DataProvider`. You can then use the `Source` objects to create a query that specifies the data that you want to retrieve from the database. To retrieve the data, you create a `Cursor` for the `Source`.

With the methods of a `Source`, you can specify selections of dimension or measure values and specify operations on the elements of the `Source`, such as mathematical calculations, comparisons, and ordering, adding or removing elements of a query. The `Source` class has a few basic methods and many shortcut methods that use one or more of the basic methods. The most complex basic methods are the `join(Source joined, Source comparison, int comparisonRule, boolean visible)` method and the `recursiveJoin(Source joined, Source comparison, Source parent, int comparisonRule, boolean parentsFirst, boolean parentsRestrictedToBase, int maxIterations, boolean visible)` method. The many other signatures of the `join` and `recursiveJoin` methods are shortcuts for certain operations of the basic methods.

In this chapter, the information about the `join` method applies equally to the `recursiveJoin` method, except where otherwise noted. With the `join` method, you can select elements of a `Source` and, most importantly, you can relate the elements of one `Source` to those of another `Source`. For example, to specify the dimension members that retrieving the data of a measure requires, you use a `join` method to relate the dimension to the measure.

A `Source` has certain characteristics, such as a type and a data type, and it sometimes has one or more inputs or outputs. This chapter describes these concepts. It also describes the different kinds of `Source` objects and how you get them, the `join` method and other `Source` methods, and how you use those methods to specify a query.

Kinds of Source Objects

The kinds of `Source` objects that you use to specify data and to perform analysis, and the ways that you get them, are the following:

- Primary `Source` objects, which are returned by the `getSource` method of an `MdmSource` object such as an `MdmDimension` or an `MdmMeasure`. A primary `Source` provides access to the data that the `MdmSource` represents. Getting primary `Source` objects is usually the first step in creating a query. You then typically select elements from the primary `Source` objects, thereby producing derived `Source` objects.
- Derived `Source` objects, which you get by calling some of the methods of a `Source` object. Methods such as `join` return a new `Source` that is based on the `Source` on which you call the method. All queries on the data store, other than a simple list of values specified by the primary `Source` for an `MdmSubdimension`, such as an `MdmLevelHierarchy` or an `MdmLevel`, are derived `Source` objects.
- Fundamental `Source` objects, which are returned by the `getSource` method of a `FundamentalMetadataObject`. These `Source` objects represent the OLAP API data types.
- List or range `Source` objects, which are returned by the `createConstantSource`, `createListSource` or `createRangeSource` methods of a `DataProvider`. Typically, you use this kind of `Source` as the `joined` or `comparison` parameter to a `join` method.
- Empty, null, or void `Source` objects. Empty and void `Source` objects are returned by the `getEmptySource` or `getVoidSource` method of a `DataProvider`, and null `Source` objects are returned by the `nullSource` method of a `Source`. An empty `Source` has no elements. A void or null `Source` has one element that has the value of `null`. The difference between them is that a void `Source` has as its type the `FundamentalMetadataObject` for the `Value` data type, and the null `Source` has as its type the `Source` whose `nullSource` method returned it. Typically, you use these kinds of `Source` objects as the `joined` or `comparison` parameter to a `join` method.
- Dynamic `Source` objects, which are returned by the `getSource` method of a `DynamicDefinition`. A dynamic `Source` is usually a derived `Source`. It is generated by a `Template`, which you use to create a dynamic query that you can revise after interacting with an end user.
- Parameterized `Source` objects, which are returned by the `createParameterizedSource` methods of a `DataProvider`. Like a list or range `Source`, you use a parameterized `Source` as a parameter to the `join` method. Unlike a list or range `Source`, however, you can change the value that

the `Parameter` represents after the join operation and thereby change the selection that the derived `Source` represents. You can create a `Cursor` for that derived `Source` and retrieve the results of the query. You can then change the value of the `Parameter`, and, without having to create a new `Cursor` for the derived `Source`, use that same `Cursor` to retrieve the results of the modified query.

- Placeholder `Source` objects, which are returned by the `getSource` method of the `FundamentalMetadataObject` that represents a placeholder for a specific data type. You get the `FundamentalMetadataObject` for a placeholder with methods of a `FundamentalMetadataProvider` such as the `getNumberPlaceholder` or `getStringPlaceholder` methods. Oracle OLAP uses placeholder `Source` objects in `Assignment` objects in an `MdmModel` or `CustomModel`. In an `Assignment`, a placeholder `Source` represents the `Source` for the current dimensioned `Source` to which the value is being assigned. You can use a placeholder `Source` in creating a custom dimension member and Oracle OLAP automatically adds an `Assignment` to the appropriate `Model`.

The `Source` class has the following subclasses:

- `BooleanSource`
- `DateSource`
- `NumberSource`
- `StringSource`

These subclasses have different data types and implement `Source` methods that require those data types. Each subclass also implements methods unique to it, such as the `implies` method of a `BooleanSource` or the `indexOf` method of a `StringSource`.

Characteristics of Source Objects

A `Source` has a data type and a type, a `Source` identification (ID), and a `SourceDefinition`. This topic describes these concepts. Some `Source` objects have one or more inputs or outputs. Those complex concepts are discussed in the "[Inputs and Outputs of a Source](#)" topic. Some `Source` objects have an associated `Model` object, which is discussed in the "[Model Objects and Source Objects](#)" topic.

Data Type of a Source

As described in [Chapter 2, "Understanding OLAP API Metadata"](#), the OLAP API has a class, `FundamentalMetadataObject`, that represents the data type of the elements of an `MdmSource`. The data type of a `Source` is represented by a fundamental `Source`. For example, a `BooleanSource` has elements that have Java boolean values. The data type of a `BooleanSource` is the fundamental `Source` that represents OLAP API Boolean values.

To get the fundamental `Source` that represents the data type of a `Source`, call the `getDataType` method of the `Source`. You can also get a fundamental `Source` by calling the `getSource` method of a `FundamentalMetadataObject`.

[Example 6-1](#) demonstrates getting the fundamental `Source` for the OLAP API String data type, the `Source` for the data type of an `MdmPrimaryDimension`, and the `Source` for the data type of the `Source` for the `MdmPrimaryDimension`, and comparing them to verify that they are all the same object. In the example, `dp` is the

DataProvider and mdmProdDim is the MdmPrimaryDimension for the Product dimension.

Example 6–1 Getting the Data Type of a Source

```
FundamentalMetadataProvider fmp = dp.getFundamentalMetadataProvider();
FundamentalMetadataObject fmoStringDataType = fmp.getStringDataType();
Source stringDataSource = fmoStringDataType.getSource();
FundamentalMetadataObject fmoMdmProdDimDataType =
    mdmProdDim.getDataType();
Source mdmProdDimDataSource = fmoMdmProdDimDataSource.getSource();
Source prodDim = mdmProdDim.getSource();
Source prodDimDataSource = prodDim.getDataType();
if (stringDataSource == prodDimDataSource &&
    mdmProdDimDataSource == prodDimDataSource)
    System.out.println("The Source objects for the data types are all the same.");
else
    System.out.println("The Source objects for the data types are not " +
        "all the same.");
```

The example displays the following:

The Source objects for the data types are all the same.

Type of a Source

Along with a data type, a Source has a type, which is the Source from which the elements of the Source are drawn. The type of a Source determines whether the join method can match the Source to an input of another Source. The only Source that does not have a type is the fundamental Source for the OLAP API Value data type, which represents the set of all values, and from which all other Source objects ultimately descend.

The type of a fundamental Source is its data type. The type of a list or range Source is the data type of the values of the elements of the list or range Source.

The type of a primary Source is one of the following:

- The fundamental Source that represents the data type of the values of the elements of the primary Source. For example, the Source returned by getSource method of a typical MdmMeasure is the fundamental Source that represents the set of all OLAP API number values.
- The Source for the MdmSource of which the MdmSource of the primary Source is a component. For example, the type of the Source returned by the getSource method of an MdmLevelHierarchy is the Source for the MdmPrimaryDimension of which the hierarchy is a component.

The type of a derived Source is one of the following:

- Its base Source, which is the Source whose method returned the derived Source. A Source returned by the alias, extract, join, recursiveJoin, or value methods, or one of their shortcuts, has its base Source as its type. An exception is the derived Source returned by the distinct method, whose type is the type of its base Source rather than the base Source itself.
- A fundamental Source. Methods such as position and count return a Source that has the fundamental Source for the OLAP API Integer data type as its type. Methods that make comparisons, such as eq, le, and so on, return a Source that has the fundamental Source for the Boolean data type as its type. Methods that perform aggregate functions, such as the NumberSource methods total and

average, return as the type of the Source a fundamental Source that represents the function.

You can find the type of a Source by calling its `getType` method.

A Source derived from another Source is a subtype of the Source from which it is derived. You can use the `isSubtypeOf` method to determine if a Source is a subtype of another Source.

For example, in [Example 6–2](#) the `myList` object is a list Source. The example uses `myList` to select values from `prodRollup`, a Source for the default `MdmLevelHierarchy` of the `MdmPrimaryDimension` for the Product dimension. In the example, `dp` is the `DataProvider`.

Example 6–2 Using the `isSubtypeOf` Method

```
Source myList = dp.createListSource(new String[] {
    "PRODUCT_ROLLUP::FAMILY::4",
    "PRODUCT_ROLLUP::FAMILY::5",
    "PRODUCT_ROLLUP::FAMILY::7",
    "PRODUCT_ROLLUP::FAMILY::8"});

Source prodSel = prodRollup.selectValues(myList);
if (prodSel.isSubtypeOf(prodRollup))
    System.out.println("prodSel is a subtype of prodRollup.");
else
    System.out.println("prodSel is not a subtype of prodRollup.");
```

Because `prodSel` is a subtype of `prodRollup`, the condition in the `if` statement is true and the example displays the following:

```
prodSel is a subtype of prodRollup.
```

The type of both `myList` and `prodRollup` is the fundamental String Source. The type of `prodSel` is `prodRollup` because the elements of `prodSel` are derived from the elements of `prodRollup`.

The supertype of a Source is the type of the type of a Source, and so on, up through the types to the Source for the fundamental Value data type. For example, the fundamental Value Source is the type of the fundamental String Source, which is the type of `prodRollup`, which is the type of `prodSel`. The fundamental Value Source and the fundamental String Source are both supertypes of `prodSel`. The `prodSel` Source is a subtype of `prodRollup`, and of the fundamental String Source, and of the fundamental Value Source.

Source Identification and SourceDefinition of a Source

A Source has an identification, an ID, which is a String that uniquely identifies it during the current connection to the database. You can get the identification of a Source by calling its `getID` method. For example, the following code gets the identification of the Source for the `MdmPrimaryDimension` for the Product dimension and displays the value.

```
System.out.println("The Source ID of prodDim is " +
    prodDim.getID());
```

The preceding code displays the following:

```
The Source ID of prodDim is Hidden..D_GLOBAL.PRODUCT
```

The text displayed by [Example 6–9](#) has several examples of Source identifications.

Each `Source` has a `SourceDefinition` object, which records information about the `Source`. The different kinds of `Source` objects have different kinds of `SourceDefinition` objects. For example, the fundamental `Source` for an `MdmPrimaryDimension` has an `MdmSourceDefinition`, which is a subclass of `HiddenDefinition`, which is a subclass of `SourceDefinition`.

The `SourceDefinition` of a `Source` that is produced by a call to the `join` method is an instance of the `JoinDefinition` class. From a `JoinDefinition` you can get information about the parameters of the join operation that produced its `Source`, such as the base `Source`, the joined `Source`, the comparison `Source`, the comparison rule, and the value of the `visible` parameter.

Inputs and Outputs of a Source

The inputs and the outputs of a `Source` are complex and powerful aspects of the class. This section describes the concepts of inputs and outputs and provides examples of how they are related.

Inputs of a Source

A `Source` that has inputs is a **dimensioned** `Source`. An input of a `Source` is also a `Source`. An input indicates that the values of the dimensioned `Source` depend upon an unspecified set of values of the input. A `Source` that matches to the input provides the values that the input requires. You match an input to a dimensioned `Source` by using the `join` method. For information on how to match a `Source` to an input, see ["Matching a Source To an Input"](#).

Certain `Source` objects always have one or more inputs. They are the `Source` objects for the `MdmDimensionedObject` subclasses `MdmMeasure` and `MdmAttribute`. They have inputs because the values of a measure or attribute are specified by the values of their dimensions. The inputs of the `Source` for the measure or attribute are the `Source` objects for the dimensions of the measure or the attribute. Before you can retrieve the data for a measure or an attribute, you must match each input to a `Source` that provides the required values.

Some `Source` methods produce a `Source` that has an input. You can produce a `Source` that has an input by using the `extract`, `position`, or `value` methods. These methods provide a means of producing a `Source` whose elements are a subset of the elements of another `Source`. A `Source` produced by one of these methods has its base `Source` as an input.

For example, in the following code, the base `Source` is `prodRollup`. Its `value` method produces `prodRollupValues`, which has `prodRollup` as an input.

```
Source prodRollupValues = prodRollup.value();
```

The input provides the means to select values from `prodRollup`, as demonstrated by [Example 6-2](#). The `selectValues` method in [Example 6-2](#) is a shortcut for the following `join` method.

```
Source prodSel = prodRollup.join(prodRollup.value(),
                               myList,
                               Source.COMPARISON_RULE_SELECT,
                               false);
```

The parameters of the `join` method specify the elements of the base `Source` that appear in the resulting `Source`. In the example, the `joined` parameter is the `Source` produced by the `prodRollup.value()` method. The resulting unnamed `Source`

has `prodRollup` as an input. The input is matched by the base of the `join` method, which is also `prodRollup`. The result of the `join` operation, `prodSel`, has the values of `prodRollup` that match the values of `prodRollup` that are in the comparison `Source`, `myList`.

If the joined `Source` were `prodRollup` and not the `Source` produced by `prodRollup.value()`, then the comparison would be between the `Source` object itself and the values of the comparison `Source` and not between the values of the `Source` and the values of the comparison `Source`. Because the joined `Source` object does not match any of the values of the comparison `Source`, the result of the `join` method would have all of the elements of `prodRollup` instead of having only the values of `prodRollup` that are specified by the values of the joined `Source` that match the values of the comparison `Source` as specified by the comparison rule.

The input of a `Source` produced by the `position` or `value` method, and an input intrinsic to an `MdmDimensionedObject`, are regular inputs. A regular input causes the `join` method, when it matches a `Source` to the input, to compare the values of the comparison `Source` to the values of the `Source` that has the input rather than to the input `Source` itself.

The input of a `Source` produced by the `extract` method is an extraction input. An extraction input differs from a regular input in that, when a value of the `Source` that has the extraction input is a `Source`, the `join` method extracts the values of the `Source` that is a value of the `Source` that has the input. The `join` method then compares the values of the comparison `Source` to the extracted values rather than to the `Source` itself.

A `Source` can have from zero to many inputs. You can get all of the inputs of a `Source` by calling its `getInputs` method, the regular inputs by calling its `getRegularInputs` method, and its extraction inputs by calling its `getExtractionInputs` method. Each of those methods returns a `Set` of `Source` objects.

Outputs of a Source

The `join` method returns a `Source` that has the elements of its base `Source` that are specified by the parameters of the method. If the value of the `visible` parameter is `true`, then the joined `Source` becomes an output of the returned `Source`. An output of a `Source` returned by the `join` method has the elements of the joined `Source` that specify the elements of the returned `Source`. An output is a means of identifying the elements of the joined `Source` that specify the elements of the `Source` that has the output.

A `Source` can have from zero to many outputs. You can get the outputs of a `Source` by calling its `getOutputs` method, which returns a `List` of `Source` objects.

A `Source` with more than one output has one or more elements for each set of the elements of the outputs. For example, a `Source` that represents a measure that has had all of its inputs matched, and has had the `Source` objects that match the inputs turned into outputs, has a single type element for each set of the elements of its outputs because each data value of the measure is identified by a unique set of the values of its dimensions. A `Source` that represents dimension values that are selected by some operation performed on the data of a measure, however, might have more than one element for each set of the elements of its outputs. An example is a `Source` that represents product values that have unit costs greater than a certain amount. Such a `Source` might have several products for each time period that have a unit cost greater than the specified amount.

[Example 6-3](#) produces a selection of the elements of `shipRollup`, which is a `Source` for a hierarchy of a dimension of customer values. The customers are grouped by a shipment origination and destination hierarchy.

Example 6-3 Using the join Method To Produce a Source Without an Output

```
Source custValuesToSelect = dp.createListSource(new String[]
    {"SHIPMENTS_ROLLUP::REGION::9",
     "SHIPMENTS_ROLLUP::REGION::10"});

Source shipRollupValues = shipRollup.value();
Source custSel = shipRollup.join(shipRollupValues,
    custValuesToSelect,
    Source.COMPARISON_RULE_SELECT,
    false);
```

The `shipRollupValues` `Source` has an input of `shipRollup`. In the `join` method in the example, the base `Source`, `shipRollup`, matches the input of the joined `Source`, `shipRollupValues` because the base and the input are the same object. The `join` method selects the elements of the base `shipRollup` whose values match the values of the joined `shipRollup` that are specified by the comparison `Source`, `custValuesToSelect`. The method produces a `Source`, `custSel`, that has only the selected elements of `shipRollup`. Because the `visible` parameter is `false`, the joined `Source` is not an output of `custSel`. The `custSel` `Source` therefore has only two elements, the values of which are `SHIPMENTS_ROLLUP::REGION::9` and `SHIPMENTS_ROLLUP::REGION::10`.

You produce a `Source` that has an output by specifying `true` as the `visible` parameter to the `join` method. [Example 6-4](#) joins the `Source` objects for the dimension selections from [Example 6-2](#) and [Example 6-3](#) to produce a `Source`, `custSelByProdSel`, that has one output. The `custSelByProdSel` `Source` has the elements from `custSel` that are specified by the elements of `prodSel`.

The comparison `Source` is an empty `Source`, which has no elements and which is the result of the `getEmptySource` method of the `DataProvider`, `dp`. The comparison rule value, `COMPARISON_RULE_REMOVE`, selects only the elements of `prodSel` that are not in the comparison `Source`. Because the comparison `Source` has no elements, all of the elements of the joined `Source` are selected. Each of the elements of the joined `Source` specify all of the elements of the base `Source`. The resulting `Source`, `custSelByProdSel`, therefore has all of the elements of `custSel`.

Because the `visible` parameter is `true` in [Example 6-4](#), `prodSel` is an output of `custSelByProdSel`. Therefore, for each element of the output, `custSelByProdSel` has the elements of `custSel` that are specified by that element of the output. Because the `custSel` and `prodSel` are both simple lists of dimension values, the result is the cross product of the elements of both `Source` objects.

Example 6-4 Using the join Method To Produce a Source With an Output

```
Source custSelByProdSel = custSel.join(prodSel,
    dp.getEmptySource(),
    Source.COMPARISON_RULE_REMOVE,
    true);
```

To actually retrieve the data specified by `custSelByProdSel`, you must create a `Cursor` for it. Such a `Cursor` contains the values shown in the following table, which has headings added that indicate that the values from the output, `prodSel`, are in the left column and the values from the elements of the `custSelByProdSel` `Source`, which are derived from its type, `custSel`, are in the right column.

Output Values	Type Values
PRODUCT_ROLLUP::FAMILY::4	SHIPMENTS_ROLLUP::REGION::9
PRODUCT_ROLLUP::FAMILY::4	SHIPMENTS_ROLLUP::REGION::10
PRODUCT_ROLLUP::FAMILY::5	SHIPMENTS_ROLLUP::REGION::9
PRODUCT_ROLLUP::FAMILY::5	SHIPMENTS_ROLLUP::REGION::10
PRODUCT_ROLLUP::FAMILY::7	SHIPMENTS_ROLLUP::REGION::9
PRODUCT_ROLLUP::FAMILY::7	SHIPMENTS_ROLLUP::REGION::10
PRODUCT_ROLLUP::FAMILY::8	SHIPMENTS_ROLLUP::REGION::9
PRODUCT_ROLLUP::FAMILY::8	SHIPMENTS_ROLLUP::REGION::10

The `custSelByProdSel` Source has two type elements, and its output has four elements. The number of elements of `custSelByProdSel` is eight because for this Source, each output element specifies the same set of two type elements.

Each join operation that specifies a visible parameter of `true` adds an output to the list of outputs of the resulting Source. For example, if a Source has two outputs and you call one of its `join` methods that produces an output, then the Source that results from the join operation has three outputs. You can get the outputs of a Source by calling its `getOutputs` method, which returns a List of Source objects.

[Example 6-5](#) demonstrates joining a measure to selections from the dimensions of the measure, thus matching to the inputs of the measure Source objects that provide the required elements. Because the last two `join` methods match the dimension selections to the inputs of the measure, the resulting Source does not have any inputs. Because the visible parameter in those joins is `true`, the last `join` method produces a Source that has two outputs.

[Example 6-5](#) gets the Source for the measure of unit costs. That Source, `unitCost`, has two inputs, which are the primary Source objects for the Time and Product dimensions, which are the dimensions of unit cost. The example gets the Source objects for level hierarchies of the dimensions, which are subtypes of the Source objects for the dimensions. It produces selections of the level hierarchies and then joins those selections to the measure. The result, `unitCostSel`, specifies the unit costs of the selected products at the selected times.

Example 6-5 Using the join Method To Match Source Objects To Inputs

```
Source unitCost = mdmUnitCost.getSource();
Source calendar = mdmCalendar.getSource();
Source prodRollup = mdmProdRollup.getSource();
Source timeSel = calendar.join(calendar.value(),
    dp.createListSource(new String[]
        {"CALENDAR::MONTH::47",
         "CALENDAR::MONTH::59"}),
    Source.COMPARISON_RULE_SELECT,
    false);
Source prodSel = prodRollup.join(prodRollup.value(),
    dp.createListSource(new String[]
        {"PRODUCT_ROLLUP::ITEM::13",
         "PRODUCT_ROLLUP::ITEM::14",
         "PRODUCT_ROLLUP::ITEM::15"}),
    Source.COMPARISON_RULE_SELECT,
    false);
Source unitCostSel = unitCost.join(timeSel,
    dp.getEmptySource(),
    Source.COMPARISON_RULE_REMOVE,
    true);
    .join(prodSel,
        dp.getEmptySource(),
```

```
Source.COMPARISON_RULE_REMOVE,
true);
```

The unnamed `Source` that results from joining `timeSel` to `unitCost` has one output, which is `timeSel`. Joining `prodSel` to that unnamed `Source` produces `unitCostSel`, which has two outputs, `timeSel` and `prodSel`. The `unitCostSel` `Source` has the elements from its type, `unitCost`, that are specified by its outputs.

A `Cursor` for `unitCostSel` contains the following, displayed as a table with headings added that indicate the structure of the `Cursor`. A `Cursor` has the same structure as its `Source`. The unit cost values are formatted as dollar values.

Output 1 Values	Output 2 Values	Type Values
PRODUCT_ROLLUP::ITEM::13	CALENDAR::MONTH::47	2897.40
PRODUCT_ROLLUP::ITEM::13	CALENDAR::MONTH::59	2376.73
PRODUCT_ROLLUP::ITEM::14	CALENDAR::MONTH::47	3238.36
PRODUCT_ROLLUP::ITEM::14	CALENDAR::MONTH::59	3015.90
PRODUCT_ROLLUP::ITEM::15	CALENDAR::MONTH::47	2847.47
PRODUCT_ROLLUP::ITEM::15	CALENDAR::MONTH::59	2819.85

Output 1 has the values from `prodSel`, output 2 has the values from `timeSel`, and the type values are the values from `unitCost` that are specified by the output values.

Because these join operations are performed by most OLAP API applications, the API provides shortcuts for these and many other join operations. [Example 6-6](#) uses shortcuts for the join operations in [Example 6-5](#) to produce the same result.

Example 6-6 Using Shortcuts

```
Source unitCost = mdmUnitCost.getSource();
StringSource calendar = (StringSource) mdmCalendar.getSource();
StringSource prodRollup = (StringSource) mdmProdRollup.getSource();
Source timeSel = calendar.selectValues(new String[]
    {"CALENDAR::MONTH::47",
     "CALENDAR::MONTH::59"}),
Source prodSel = prodRollup.selectValues(new String[]
    {"PRODUCT_ROLLUP::ITEM::13",
     "PRODUCT_ROLLUP::ITEM::14",
     "PRODUCT_ROLLUP::ITEM::15"}),
Source unitCostSel = unitCost.join(timeSel).join(prodSel);
```

Matching a Source To an Input

In a join operation, a `Source`-to-input match occurs only between the base `Source` and the joined `Source`. A `Source` matches an input if one of the following conditions is true.

1. The `Source` is the same object as the input or it is a subtype of the input.
2. The `Source` has an output that is the same object as the input or the output is a subtype of the input.
3. The output has an output that is the same object as the input or is a subtype of the input.

The join operation looks for the conditions in the order in the preceding list. It searches the list of outputs of the `Source` recursively, looking for a match to the input. The search ends with the first matching `Source`. An input can match with only one `Source`, and two inputs cannot match with the same `Source`.

When a Source matches an input, the result of the `join` method has the elements of the base that match the elements specified by the parameters of the method. You can determine if a Source matches another Source, or an output of the other Source, by passing the Source to the `findMatchFor` method of the other Source.

When a Source matches an input, the resulting Source does not have that input. Matching a Source to an input does not affect the outputs of the base Source or the joined Source. If a base Source has an output that matches the input of the joined Source, the resulting Source does not have the input but it does have the output.

If the base Source or the joined Source in a join operation has an input that is not matched in the operation, then the unmatched input is an input of the resulting Source.

The comparison Source of a join method does not participate in the input matching. If the comparison Source has an input, then that input is not matched and the Source returned by the join method has that same input.

[Example 6-7](#) demonstrates a base Source matching the input of the joined Source in a join operation. The example uses the `position` method to produce a Source that has an input, and then uses the `join` method to match the base of the join operation to the input of the joined Source.

Example 6-7 Matching the Base Source to an Input of the Joined Source

```
Source myList = dp.createListSource(new String[]
    "PRODUCT_ROLLUP::FAMILY::4",
    "PRODUCT_ROLLUP::FAMILY::5",
    "PRODUCT_ROLLUP::FAMILY::7",
    "PRODUCT_ROLLUP::FAMILY::8");
Source pos = dp.createListSource(new int[] {2, 4});
Source myListPos = myList.position();
Source myListSel = myList.join(myListPos, pos,
    Source.COMPARISON_RULE_SELECT, false);
```

In [Example 6-7](#), the `position` method returns `myListPos`, which has the elements of `myList` and which has `myList` as an input. The `join` method matches the base `myList` to the input of the joined Source, `myListPos`.

The comparison Source, `pos`, specifies the positions of the elements of `myListPos` to match to the positions of the elements of `myList`. The elements of the resulting Source, `myListSel`, are the elements of `myList` whose positions match those specified by the parameters of the `join` method.

A Cursor for `myListSel` has the following values.

```
PRODUCT_ROLLUP::FAMILY::5
PRODUCT_ROLLUP::FAMILY::8
```

If the `visible` parameter in [Example 6-7](#) were `true` instead of `false`, then the result would have elements from `myList` and an output of `myListPos`. A Cursor for `myListSel` in that case would have the following values, displayed as a table with headings added that indicate the output and type values.

Output Values	Type Values
2	PRODUCT_ROLLUP::FAMILY::5
4	PRODUCT_ROLLUP::FAMILY::8

Example 6–8 demonstrates matching outputs of the joined `Source` to two inputs of the base `Source`. In the example, `units` is a `Source` for an `MdmMeasure`. It has as inputs the primary `Source` objects for the `Time`, `Product`, `Customer`, and `Channel` dimensions.

The `DataProvider` is `dp`, and `prodRollup`, `shipRollup`, `calendar`, and `chanRollup` are the `Source` objects for the default hierarchies of the `Product`, `Customer`, `Time`, and `Channel` dimensions, respectively. Those `Source` objects are subtypes of the `Source` objects for the dimensions that are the inputs of `units`.

The `join` method of `prodRollup` in the first line of **Example 6–8** results in `prodSel`, which specifies selected product values. In that method, the joined `Source` is the result of the `value` method of `prodRollup`. The joined `Source` has the same elements as `prodRollup`, and it has `prodRollup` as an input. The comparison `Source` is the list `Source` that is the result of the `createListSource` method of the `DataProvider`.

The base `Source` of the `join` method, `prodRollup`, matches the input of the joined `Source`. Because `prodRollup` is the input of the joined `Source`, the `Source` returned by the `join` method has only the elements of the base, `prodRollup`, that match the elements of the joined `Source` that appear in the comparison `Source`. Because the `visible` parameter value is `false`, the resulting `Source` does not have the joined `Source` as an output. The next three similar `join` operations in **Example 6–8** result in selections for the other three dimensions.

The `join` method of `timeSel` has `custSel` as the joined `Source`. Its comparison `Source` is the result of the `getEmptySource` method, so it has no elements. The comparison rule specifies that the elements of the joined `Source` that are present in the comparison `Source` do not appear in the resulting `Source`. Because the comparison `Source` has no elements, all of the elements of the joined `Source` are selected. The `true` value for the `visible` parameter causes the joined `Source` to be an output of the `Source` returned by the `join` method. The returned `Source`, `custSelByTime`, has the selected elements of the `Customer` dimension and has `timeSel` as an output.

The `join` method of `prodSel` has `custSelByTime` as the joined `Source`. It produces `prodByCustByTime`, which has the selected elements from the `Product` dimension and has `custSelByTime` as an output. **Example 6–8** then joins the dimension selections to the `units` `Source`.

The dimension selections are subtypes of the `Source` objects that are the inputs of `units`, and therefore the selections match the inputs of `units`. The input for the `Product` dimension is matched by `prodByCustByTime` because `prodByCustByTime` is a subtype of `prodSel`, which is a subtype of `prodRollup`. The input for the `Customer` dimension is matched by the `custSelByTime`, which is the output of `prodByCustByTime`.

The `custSelByTime` `Source` is a subtype of `custSel`, which is a subtype of `shipRollup`. The input for the `times` dimension is matched by `timeSel`, which is the output of `custSelByTime`. The `timeSel` `Source` is a subtype of `calendar`.

Example 6–8 Matching an Input of the Base Source to an Output of the Joined Source

```
Source prodSel = prodRollup.join(prodRollup.value(),
                                dp.createListSource(new String[]
                                    {"PRODUCT_ROLLUP::FAMILY::4",
                                     "PRODUCT_ROLLUP::FAMILY::5"}),
                                Source.COMPARISON_RULE_SELECT,
                                false);
Source custSel = shipRollup.join(shipRollup.value(),
```

```

        dp.createListSource(new String[]
            {"SHIPMENTS_ROLLUP::REGION::9",
             "SHIPMENTS_ROLLUP::REGION::10"}),
        Source.COMPARISON_RULE_SELECT,
        false);
Source timeSel = calendar.join( calendar.value(),
    dp.createConstantSource(
        "CALENDAR::YEAR::4"),
    Source.COMPARISON_RULE_SELECT,
    false);
Source chanSel = chanRollup.join(chanRollup.value(),
    dp.createConstantSource(
        "CHANNEL_ROLLUP::CHANNEL::4"),
    Source.COMPARISON_RULE_SELECT,
    false);

Source custSelByTime = custSel.join(timeSel,
    dp.getEmptySource(),
    Source.COMPARISON_RULE_REMOVE,
    true);
Source prodByCustByTime = prodSel.join(custSelByTime,
    dp.getEmptySource(),
    Source.COMPARISON_RULE_REMOVE,
    true);

Source selectedUnits = units.join(prodByCustByTime,
    dp.getEmptySource(),
    Source.COMPARISON_RULE_REMOVE,
    true)
    .join(promoSel,
    dp.getEmptySource(),
    Source.COMPARISON_RULE_REMOVE,
    true ),
    .join(chanSel,
    dp.getEmptySource(),
    Source.COMPARISON_RULE_REMOVE,
    true);

```

A Cursor for `selectedUnits` contains the following values, displayed in a crosstab format with column headings and formatting added. The table has only the local values of the dimension elements. The first two lines are the page edge values of the crosstab, which are the values of the `chanSel` output of `selectedUnits`, and the value of `timeSel`, which is an output of the `prodByCustByTime` output of `selectedUnits`. The row edge values of the crosstab are the customer values in the left column, and the column edge values are the products values that head the middle and right columns.

The crosstab has only the local value portion of the unique values of the dimension elements. The measure values are the units sold values specified by the selected dimension values.

```

4
4
          Products
          -----
Customers  4      5
-----  ---  ----
9          215   439
10         846  1748

```

The following table has the same results except that the dimension element values are replaced by the short descriptions of those values.

Internet		Products	
2001			
Customers	Portable PCs	Desktop PCs	
Europe	215	439	
North America	846	1748	

To demonstrate turning inputs into outputs, [Example 6–9](#) uses `units`, which is the Source for the Units measure, and `defaultHiers`, which is an `ArrayList` of the Source objects for the default hierarchies of the dimensions of the measure. The example gets the inputs and outputs of the Source for the measure. It displays the Source identifications of the Source for the measure and for its inputs. The inputs of the Source for the measure are the Source objects for the `MdmPrimaryDimension` objects that are the dimensions of the measure.

[Example 6–9](#) next displays the number of inputs and outputs of the Source for the measure. Using the `join(Source joined)` method, which produces a Source that has the elements of the base of the join operation as its elements and the `joined` parameter Source as an output, it joins one of the hierarchy Source objects to the Source for the measure, and displays the number of inputs and outputs of the resulting Source. It then joins each remaining hierarchy Source to the result of the previous join operation and displays the number of inputs and outputs of the resulting Source.

Finally the example gets the outputs of the Source produced by the last join operation, and displays the Source identifications of the outputs. The outputs of the last Source are the Source objects for the default hierarchies, which the example joined to the Source for the measure. Because the Source objects for the hierarchies are subtypes of the Source objects for the `MdmPrimaryDimension` objects that are the inputs of the measure, they match those inputs.

Example 6–9 Matching the Inputs of a Measure and Producing Outputs

```
Set inputs = units.getInputs();
Iterator inputsItr = inputs.iterator();
List outputs = units.getOutputs();
Source input = null;

int i = 1;
System.out.println("The inputs of " + units.getID() + " are:");
while(inputsItr.hasNext())
{
    input = (Source) inputsItr.next();
    System.out.println(i + ": " + input.getID());
    i++;
}

System.out.println(" ");
int setSize = inputs.size();
for(i = 0; i < (setSize + 1); i++)
{
    System.out.println(units.getID() + " has " + inputs.size() +
        " inputs and " + outputs.size() + " outputs.");
    if (i < setSize)
    {
```

```

        input = defaultHiers.get(i);
        System.out.println("Joining " + input.getID() + " to "
                           + units.getID());

        units = units.join(input);
        inputs = units.getInputs();
        outputs = units.getOutputs();
    }
}

System.out.println(" ");
System.out.println("The outputs of " + units.getID() + " are:");
Iterator outputsItr = outputs.iterator();
i = 1;
while(outputsItr.hasNext())
{
    Source output = (Source) outputsItr.next();
    System.out.println(i + ": " + output.getID());
    i++;
}

```

The text displayed by the example is the following:

The inputs of Hidden..M_GLOBAL.UNITS_CUBE.UNITS are:

- 1: Hidden..D_GLOBAL.TIME
- 2: Hidden..D_GLOBAL.PRODUCT
- 3: Hidden..D_GLOBAL.CUSTOMER
- 4: Hidden..D_GLOBAL.CHANNEL

Hidden..M_GLOBAL.UNITS_CUBE.UNITS has 4 inputs and 0 outputs.

Joining Hidden..D_GLOBAL.PRODUCT.PRODUCT_ROLLUP to
Hidden..M_GLOBAL.UNITS_CUBE.UNITS

Join.0 has 3 inputs and 1 outputs.

Joining Hidden..D_GLOBAL.CUSTOMER.SHIPMENTS_ROLLUP to Join.0

Join.1 has 2 inputs and 2 outputs.

Joining Hidden..D_GLOBAL.TIME.CALENDAR to Join.1

Join.2 has 1 inputs and 3 outputs.

Joining Hidden..D_GLOBAL.CHANNEL.CHANNEL_ROLLUP to Join.2

Join.3 has 0 inputs and 5 outputs.

The outputs of Join.3 are:

- 1: Hidden..D_GLOBAL.CHANNEL.CHANNEL_ROLLUP
- 2: Hidden..D_GLOBAL.TIME.CALENDAR
- 3: Hidden..D_GLOBAL.CUSTOMER.SHIPMENTS_ROLLUP
- 4: Hidden..D_GLOBAL.PRODUCT.PRODUCT_ROLLUP

Note that as each successive Source for a hierarchy is joined to the result of the previous join operation, it becomes the first output in the List of outputs of the resulting Source. Therefore, the first output of Join.3 is Hidden..D_GLOBAL.CHANNEL.CHANNEL_ROLLUP, and its last output is Hidden..D_GLOBAL.PRODUCT.PRODUCT_ROLLUP.

Describing Parameterized Source Objects

Parameterized Source objects provide a way of specifying a query and retrieving different result sets for the query by changing the set of elements specified by the parameterized Source. You create a parameterized Source with a `createParameterizedSource` method of the `DataProvider` that you are using. In creating the parameterized Source, you supply a `Parameter` object. The `Parameter` supplies the value that the parameterized Source specifies.

Parameter objects are similar to `CursorInput` objects in that you use them to specify an initial value for a `Source` that is part of a query. A typical use of both `Parameter` and `CursorInput` objects is to specify the page edges of a cube.

[Example 7-9](#) demonstrates using `Parameter` objects to specify page edges.

An advantage of `Parameter` objects over `CursorInput` objects is that with `Parameter` objects you can easily fetch from the server only the set of elements that you currently need. [Example 7-16](#) demonstrates using `Parameter` objects to fetch different sets of elements.

When you create a `Parameter` object, you supply an initial value for the `Parameter`. You then create the parameterized `Source` using the `Parameter`. You include the parameterized `Source` in specifying a query. You create a `Cursor` for the query. You can change the value of the `Parameter` with its `setValue` method, which changes the set of elements that the query specifies. Using the same `Cursor`, you can then display the new set of values.

[Example 6-10](#) demonstrates the use of a `Parameter` and a parameterized `Source` to specify an element in a measure dimension. It creates a list `Source` that has as its element values the `Source` objects for `Unit Cost` and `Unit Price` measures. The example creates a `StringParameter` object that has as its initial value the unique identifying `String` for the `Source` for the `Unit Cost` measure. That `StringParameter` is then used to create a parameterized `Source`.

The example extracts the values from the measures, and then selects the data values that are specified by joining the dimension selections to the measure specified by the parameterized `Source`. It creates a `Cursor` for the resulting query and displays the results. After resetting the `Cursor` position and changing the value of the `measParamStringParameter`, the example displays the values of the `Cursor` again.

The `dp` object is the `DataProvider`. The `context` object has a method that displays the values of the `Cursor` with only the local value of the dimension elements.

Example 6-10 Using a Parameterized Source With a Measure Dimension

```
Source measDim = dp.createListSource(new Source[] {unitCost,
                                                unitPrice});

// Get the unique identifiers of the Source objects for the measures.
String unitCostID = unitCost.getID();
String unitPriceID = unitPrice.getID();

// Create a StringParameter using one of the IDs as the initial value.
StringParameter measParam = new StringParameter(dp, unitCostID);

// Create a parameterized Source.
StringSource measParamSrc = dp.createParameterizedSource(measParam);

// Extract the values from the measure dimension elements, and join
// them to the specified measure and the dimension selections.
Source result = measDim.extract().join(measDim, measParamSrc)
                            .join(prodSelShortDescr)
                            .join(timeSelShortDescr);

// Get the TransactionProvider and prepare and commit the
// current transaction. These operations are not shown.

// Create a Cursor.
CursorManagerSpecification cMgrSpec =
    dp.createCursorManagerSpecification(results);
SpecifiedCursorManager spCMngr = dp.createCursorManager(cMgrSpec);
```

```

Cursor resultsCursor = spCMngr.createCursor();

// Display the results.
context.displayCursor(resultsCursor, true);

//Reset the Cursor position to 1.
resultsCursor.setPosition(1);

// Change the value of the parameterized Source.
measParam.setValue(unitPriceID);

// Display the results again.
context.displayCursor(resultsCursor, true);

```

The following table displays the first set of values of `resultsCursor`, with column headings and formatting added. The left column of the table has the local value of the Time dimension hierarchy. The second column from the left has the short value description of the time value. The third column has the local value of the Product dimension hierarchy. The fourth column has the short value description of the product value. The fifth column has the Unit Cost measure value for the time and product.

Time	Description	Product	Description	Unit Cost
58	Apr-01	13	Envoy Standard	2360.78
58	Apr-01	14	Envoy Executive	2952.85
59	May-01	13	Envoy Standard	2376.73
59	May-01	14	Envoy Executive	3015.90

The following table displays the second set of values of `resultsCursor` in the same format. This time the fifth column has values from the Unit Price measure.

Time	Description	Product	Description	Unit Price
58	Apr-01	13	Envoy Standard	2412.42
58	Apr-01	14	Envoy Executive	3107.65
59	May-01	13	Envoy Standard	2395.63
59	May-01	14	Envoy Executive	3147.85

Model Objects and Source Objects

This topic describes the `Model` interface and its implementations, and the relationship of `Model` and `Source` objects. It also presents examples of creating custom `Model` objects and performing other tasks that involve `Source` and `Model` objects.

Describing the Model for a Source

Introduced to the OLAP API in Oracle Database 10.2, a `Model` is analogous to the Oracle SQL `Model` clause and an Oracle DML `Model` object. With a `Model` you can assign a value to the `Source` for a dimensioned object for one or more sets of members of the dimensions of the object. The value that the `Model` assigns can be anything from a simple constant to the result of a complex calculation involving several other `Source` objects with nested `Model` objects.

The value that a `Model` assigns for a set of dimension members is represented by an `Assignment` object. A `Model` can have one or more `Assignment` objects. Each dimension member in the set is represented by a `Qualification` object. An `Assignment` has one or more `Qualification` objects.

The value that the `Assignment` assigns is specified by a `Source`. An `Assignment` also has an integer that specifies a precedence that affects the order in which Oracle OLAP calculates a value and assigns it. If you create more than one `Assignment` for a `Model` without specifying a precedence, then the order in which Oracle OLAP calculates and assigns the values is not guaranteed.

A `Model` assigns values for existing dimension members. You can use a `Model` to assign a different value for a dimension member, or to assign a value for a set of members of more than one dimension, or to assign a different value for a specific measure for the set of dimension members, or to assign a value for the dimension member for an attribute.

When you create a custom dimension member, you specify an assignment value for it. Oracle OLAP automatically adds an `Assignment` object that specifies the value for the custom member to the appropriate `Model` for the dimension. Oracle OLAP assigns that value as the measure value for any measure dimensioned by the dimension.

Figure 6–1 illustrates the class hierarchy of the `Model` interface and the classes that implement it. The `oracle.olapi.metadata.mdm.MdmModel` class implements the `Model` interface for `MdmObject` objects. Another implementation of the `Model` interface is the `CustomModel` class in the `oracle.olapi.data.source` package.

Figure 6–1 Model Interface and its Implementations

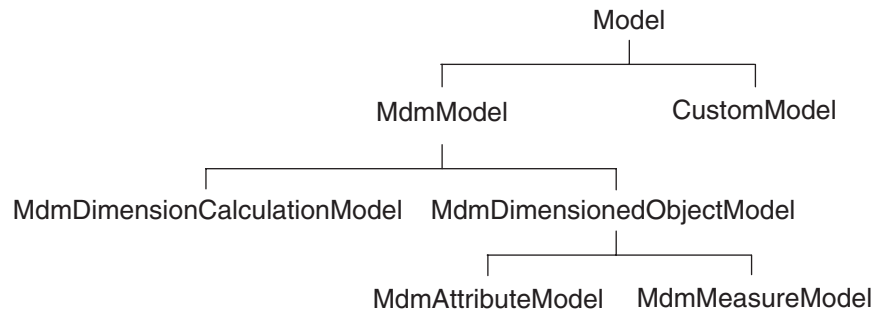

A `Model` has one or more inputs, which are the `Source` objects for which the model assigns values. The inputs are equivalent to the list of dimensions of an OLAP DML or SQL `Model`. For example, the `MdmDimensionCalculationModel` returned by the `getNumberCalcModel` method of an `MdmStandardDimension` has as its input the `Source` for that same `MdmStandardDimension`. The `MdmDimensionedObjectModel` returned by the `getModel` method of an `MdmAttribute` has as its input the `Source` for the `MdmPrimaryDimension` that dimension the attribute. The `MdmDimensionedObjectModel` returned by `getModel` method of an `MdmMeasure` has as its inputs the `Source` objects for the `MdmPrimaryDimension` objects that dimension the measure.

A `Model` can have one or more parents, which are other `Model` objects from which the `Model` inherits `Assignment` objects. An `MdmMeasureModel` has as its parents the `MdmDimensionCalculationModel` objects of its dimensions. `MdmAttributeModel` and `MdmDimensionCalculationModel` objects do not have parent `Model` objects.

A `CustomModel` can have inputs and it can have parent `Model` objects. When you create a `CustomModel` object, you can specify inputs and parent `Model` objects for it. A `CustomModel` can also have outputs, which `MdmModel` objects do not have.

You can create a series of `CustomModel` objects and have them inherit `Assignment` objects from each other. The following restrictions apply to the inheritance of an `Assignment` by one `CustomModel` from another:

- The inheritance cannot be circular. For example, if `customModelB` inherits from `customModelA`, then `customModelA` cannot inherit from `customModelB`.
- The type and the outputs of the `CustomModel` objects must be the same.
- If a parent `CustomModel` has an input, then the child `CustomModel` must also specify that input. The child `CustomModel` can have additional inputs, but it must specify the inputs of the parent `CustomModel` objects.

After creating a `CustomModel` and adding any assignments to it, you can create a `Source` for it by calling the `createSolvedSource` method of the `CustomModel`. With the `defaultValues` parameter of the `createSolvedSource` method, you can specify a `Source` that supplies default values for the `Source` returned by the method. If you do not specify a `Source` for the default values, then the default values of the resulting `Source` are null.

Creating a CustomModel - Example

The `Source.extract` method is now implemented as a `CustomModel`. An advantage of using your own `CustomModel` over the `extract` method is that you can assign the measure value to a `String` other than a `Source ID`. [Example 6–11](#) demonstrates using the `extract` method and then using a `CustomModel` to achieve the same result. It also demonstrates using another `CustomModel` to achieve a result that assigns the measure values to a different set of `String` values.

In the example, `unitPrice` and `unitCost` are `NumberSource` objects for the `Unit Price` and `Unit Cost` measures, and `dp` is the `DataProvider`. The `prodSel` object is a `Source` that represents the selection of three members of the `Product` dimension.

Example 6–11 Implementing the extract method as a CustomModel

```
// Create a Source that represents a calculation involving two measures.
Source calculation = unitPrice.minus(unitCost);

// Create a list Source that has Source objects as its element values.
Source sourceListSrc = dp.createListSource(new Source[]
    {unitPrice, unitCost, calculation});

// Use the extract method to get the values of the Source components of the
// list and join Source objects that match the inputs.
Source resultUsingExtract = sourceListSrc.extract()
    .join(sourceListSrc)
    .join(prodSel)
    .join(calendar, "CALENDAR::YEAR::3");

// Produce the same result using a CustomModel directly.
CustomModel customModel = dp.createModel(sourceListSrc);
customModel.assign(unitPrice.getID(), unitPrice);
customModel.assign(unitCost.getID(), unitCost);
customModel.assign(calculation.getID(), calculation);
Source measValForSrc = customModel.createSolvedSource();
Source resultUsingCustomModel =
    measValForSrc.join(sourceListSrc)
        .join(prodSel)
        .join(calendar, "CALENDAR::MONTH::47");
```

```

// Create a list Source that has String objects as its element values.
Source stringListSrc = dp.createListSource(new String[]
                                         {"price", "cost", "markup"});
// Create a CustomModel for the list Source.
CustomModel customModel2 = dp.createModel(stringListSrc);
customModel2.assign("price", unitPrice);
customModel2.assign("cost", unitCost);
customModel2.assign("markup", calculation);
Source measValForSrc2 = customModel2.createSolvedSource();

Source resultUsingCustomModel2 =
    measValForSrc2.join(stringListSrc)
                  .join(prodSel)
                  .join(calendar, "CALENDAR::MONTH::47");

```

Cursor objects for `resultUsingExtract` and `resultUsingCustomModel` have the same values, which are the following, shown with formatting added:

PRODUCT_ROLLUP::ITEM::13	Hidden	.M_GLOBAL.PRICE_CUBE.UNIT_PRICE	3118.61
PRODUCT_ROLLUP::ITEM::13	Hidden	.M_GLOBAL.PRICE_CUBE.UNIT_COST	2897.40
PRODUCT_ROLLUP::ITEM::13	Join.2		221.21
PRODUCT_ROLLUP::ITEM::14	Hidden	.M_GLOBAL.PRICE_CUBE.UNIT_PRICE	3442.86
PRODUCT_ROLLUP::ITEM::14	Hidden	.M_GLOBAL.PRICE_CUBE.UNIT_COST	3238.36
PRODUCT_ROLLUP::ITEM::14	Join.2		204.50
PRODUCT_ROLLUP::ITEM::15	Hidden	.M_GLOBAL.PRICE_CUBE.UNIT_PRICE	2962.14
PRODUCT_ROLLUP::ITEM::15	Hidden	.M_GLOBAL.PRICE_CUBE.UNIT_COST	2847.47
PRODUCT_ROLLUP::ITEM::15	Join.2		114.67

A Cursor for `resultUsingCustomModel2` has the following values, shown with formatting added:

PRODUCT_ROLLUP::ITEM::13	price	3118.61
PRODUCT_ROLLUP::ITEM::13	cost	2897.40
PRODUCT_ROLLUP::ITEM::13	markup	221.21
PRODUCT_ROLLUP::ITEM::14	price	3442.86
PRODUCT_ROLLUP::ITEM::14	cost	3238.36
PRODUCT_ROLLUP::ITEM::14	markup	204.50
PRODUCT_ROLLUP::ITEM::15	price	2962.14
PRODUCT_ROLLUP::ITEM::15	cost	2847.47
PRODUCT_ROLLUP::ITEM::15	markup	114.67

Dependent Assignment Values - Example

The value that is specified by the assigned Source of an Assignment object can be the result of a calculation that involves another Assignment object. Each custom member adds an Assignment to the appropriate `MdmDimensionCalculationModel` object of the dimension.

[Example 6-12](#) creates the same custom member of the Product dimension that [Example 2-1](#) creates. It then creates a second custom member for the dimension. In [Example 6-12](#), the value assigned by the second custom member depends on the value assigned by the first custom member.

As in [Example 2-1](#), [Example 6-12](#) uses the `DataProvider` object, `dp`, to get the placeholder Source, `ph`, for the Number data type from the `DataProvider`. The example uses the placeholder in defining the objects, `calc` and `dependentCalc`, that define the values that Oracle OLAP assigns for the custom members.

The `calc` object defines the value assigned for the first custom member as the value specified by product item 14 plus the value specified by item 15. The `dependentCalc` object defines the value assigned for the second custom member as the value specified by the first custom member, product item 60, plus the value specified by item 13.

The `prodSel` object specifies the dimension members for items 13, 14, and 15 and the custom members, items 60 and 61. The `unitCost` and `unitPrice` objects are `Source` objects for the Unit Cost and Unit Price measures, and the `calendar` object is the `Source` for the Calendar hierarchy of the Time dimension.

The `result` object is the query produced by joining the `Source` objects for the Unit Cost and Unit Price measures to the `Source` objects for the selected members of the dimensions of the measures. The `join` method used to join the Time dimension value, `CALENDAR::MONTH::47`, to the result of the previous `join` operations causes the Time value to not appear in the `result` object.

Example 6–12 Creating an Assignment That Depends on Another Assignment

```
Source ph = dp.getFundamentalMetadataProvider()
           .getNumberPlaceholder()
           .getSource();

Source calc = ((NumberSource)
              (ph.join(prodRollup, "PRODUCT_ROLLUP::ITEM::14")))
              .plus(
              (NumberSource)
              (ph.join(prodRollup, "PRODUCT_ROLLUP::ITEM::15")));

MdmStandardMember mdmItem60 = mdmProdStdDim.createCustomMember("60",
                                                                mdmItemLevel,
                                                                "4",
                                                                calc,
                                                                10);

Source dependentCalc = ((NumberSource)
                       (ph.join(prodRollup, "PRODUCT_ROLLUP::ITEM::60")))
                       .plus(
                       (NumberSource)
                       (ph.join(prodRollup, "PRODUCT_ROLLUP::ITEM::13")));

MdmStandardMember mdmItem61 = mdmProdStdDim.createCustomMember("61",
                                                                mdmItemLevel,
                                                                "4",
                                                                dependentCalc,
                                                                10);

StringSource prodSel = prodRollup.selectValues(
    new String[]{"PRODUCT_ROLLUP::ITEM::13",
                "PRODUCT_ROLLUP::ITEM::14",
                "PRODUCT_ROLLUP::ITEM::15",
                "PRODUCT_ROLLUP::ITEM::60",
                "PRODUCT_ROLLUP::ITEM::61"});

Source result = unitPrice.join(unitCost)
                  .join(prodSel)
                  .join(calendar, "CALENDAR::MONTH::47");
```

A Cursor for `result` has the following values, with column headings and formatting added:

Product Item	Cost	Price
PRODUCT_ROLLUP::ITEM::13	2897.40	3118.61
PRODUCT_ROLLUP::ITEM::14	3238.36	3442.86
PRODUCT_ROLLUP::ITEM::15	2847.47	2962.14
PRODUCT_ROLLUP::ITEM::60	6085.83	6405.00
PRODUCT_ROLLUP::ITEM::61	8983.23	9523.61

A Custom Member That Specifies an Aggregated Value - Example

[Example 6–13](#) creates a custom member of the Product dimension that has an assigned value that is the result of an aggregation operation. The example uses the `Source` for a custom `MdmAttribute` that relates colors to dimension members in the Item level of dimension hierarchy.

Like [Example 6–12](#), this example uses a placeholder `Source`, `ph`, in creating the `calc` object, which defines the value that Oracle OLAP assigns for the custom member. The `calc` object represents the total of the values specified by a set of dimension members.

The example creates the custom member and then specifies a short value description for it. Next, the example appends the custom member to the selection of green products. Finally, it produces the `result` query by joining the `Source` for the Units measure to the `Source` objects for the short value description of the Product dimension and the selected members of the dimensions of the measure. The particular `join` method that is used to join the Customer dimension value, `SHIPMENTS_ROLLUP::SHIP_TO::106`, the Channel dimension value, `CHANNEL_ROLLUP::ALL_CHANNELS::1`, and the Time dimension value, `CALENDAR::YEAR::3`, to the result of the previous `join` operations causes the Customer, Channel, and Time values to not appear in the `result` object.

Example 6–13 *Creating a Custom Member That Assigns an Aggregated Value*

```
// Create a Source that has the green products.
Source greenProducts = itemLevel.join(prodColorAttr, "Green");

Source calc = ((NumberSource)
    (ph.join(prodRollup,
        new String[] { "PRODUCT_ROLLUP::ITEM::25",
                      "PRODUCT_ROLLUP::ITEM::26",
                      "PRODUCT_ROLLUP::ITEM::30",
                      "PRODUCT_ROLLUP::ITEM::31"}))) .total();

MdmStandardMember mdmGreenProdTotal =
    mdmProdStdDim.createCustomMember("65", // member local value
    mdmItemLevel, // member level
    "4", // parent local value
    calc, // calculation Source
    10); // precedence value

mdmGreenProdTotal.setShortDescription("Green Products Total");

Source greenProdWithTotal =
    greenProducts.appendValue(prodRollup.selectValue("PRODUCT_ROLLUP::ITEM::65"));
```

```
Source result = units.join(prodShortDescr.join(greenProdWithTotal))
                .join(shipRollup, "SHIPMENTS_ROLLUP::SHIP_TO::106")
                .join(chanRollup, "CHANNEL_ROLLUP::ALL_CHANNELS::1")
                .join(calendar, "CALENDAR::YEAR::3");
```

The following is a crosstab display of the values of a Cursor for result. The display includes only the local value of the Product dimension members and has column headings and formatting added.

Product	Description	Units Sold
25	SIMM- 8MB PCMCIAII card	64
26	SIMM- 16MB PCMCIAII card	21
30	Mouse Pad	277
31	1.44MB External 3.5 Diskette	52
65	Green Products Total	414

Making Queries Using Source Methods

You create a query by producing a `Source` that specifies the data that you want to retrieve from the data store and any operations that you want to perform on that data. To produce the query, you begin with the primary `Source` objects that represent the metadata of the measures and the dimensions and their attributes that you want to query. Typically, you use the methods of the primary `Source` objects to derive a number of other `Source` objects, each of which specifies a part of the query, such as a selection of dimension elements or an operation to perform on the data. You then join the primary and derived `Source` objects that specify the data and the operations that you want. The result is one `Source` that represents the query.

This chapter briefly describes the various kinds of `Source` methods, and discusses some of them in greater detail. It also discusses how to make some typical OLAP queries using these methods and provides examples of some of them.

This chapter includes the following topics:

- [Describing the Basic Source Methods](#)
- [Using the Basic Methods](#)
- [Using Other Source Methods](#)

For the complete code of the examples in this chapter, see the example programs available from the Overview of the *Oracle OLAP Java API Reference*.

Describing the Basic Source Methods

The `Source` class has many methods that return a derived `Source`. The elements of the derived `Source` result from operations on the base `Source`, which is the `Source` whose method is called that produces the derived `Source`. Only a few methods perform the most basic operations of the `Source` class.

The `Source` class has many other methods that use one or more of the basic methods to perform operations such as selecting elements of the base `Source` by value or by position, or sorting elements. Many of the examples in this chapter and in [Chapter 6, "Understanding Source Objects"](#) use some of these methods. Other `Source` methods get objects that have information about the `Source`, such as the `getDefinition`, `getInputs`, and `getType` methods, or convert the values of the `Source` from one data type to another, such as the `toDoubleSource` method.

This section describes the basic `Source` methods and provides some examples of their use. [Table 7-1](#) lists the basic `Source` methods.

Table 7-1 The Basic Source Methods

Method	Description
alias	Produces a Source that has the same elements as its base Source, but has its base Source as its type.
distinct	Produces a Source that has the same elements as its base Source, except that any elements that are duplicated in the base appear only once in the derived Source.
join	Produces a Source that has the elements of its base Source that are specified by the <code>joined</code> , <code>comparison</code> , and <code>comparisonRule</code> parameters of the method call. If the <code>visible</code> parameter is <code>true</code> , then the joined Source is an output of the resulting Source.
position	Produces a Source that has the positions of the elements of its base Source, and that has its base Source as a regular input.
recursiveJoin	Similar to the <code>join</code> method, except that this method, in the Source that it produces, orders the elements of the Source hierarchically by parent-child relationships.
value	Produces a Source that has the same elements as its base Source, but that has its base Source as a regular input.

Using the Basic Methods

This section provides examples of using some of the basic methods.

Using the alias Method

You use the `alias` method to control the matching of a Source to an input. For example, if you want to find out if the measure values specified by an element of a dimension of the measure are greater than the measure values specified by the other elements of the same dimension, then you need to match the inputs of the measure twice in the same join operation. To do so, you can produce two Source objects that are aliases for the same dimension, make them inputs of two instances of the measure, join each measure instance to its aliased dimension, and then compare the results.

[Example 7-1](#) performs such an operation. It produces a Source that specifies whether the number of units sold for each value of the channel dimension is greater than the number of units sold for the other values of the channel dimension.

The example joins to `units`, which is the Source for a measure, Source objects that are selections of single values of three of the dimensions of the measure to produce `unitsSel`. The `unitsSel` Source specifies the `units` elements for the dimension values that are specified by the `timeSel`, `custSel`, and `prodSel` objects, which are outputs of `unitsSel`.

The `timeSel`, `custSel`, and `prodSel` Source objects specify single values from the default hierarchies of the Time, Customer, and Product dimensions, respectively. The `timeSel` value is `CALENDAR::MONTH::55`, which identifies the month January, 2001, the `custSel` value is `SHIPMENTS_ROLLUP::SHIP_TO::52`, which identifies the Business Word San Jose customer, and the `prodSel` value is `PRODUCT_ROLLUP::ITEM::15`, which identifies the Envoy Ambassador portable PC.

The example next creates two aliases, `chanAlias1` and `chanAlias2`, for `chanHier`, which is the default hierarchy of the Channel dimension. It then produces `unitsSel1` by joining `unitsSel` to the Source that results from calling the `value` method of `chanAlias1`. The `unitsSel1` Source has the elements and outputs of `unitsSel`

and it has `chanAlias1` as an input. Similarly, the example produces `unitsSel2`, which has `chanAlias2` as an input.

The example uses the `gt` method of `unitsSel1`, which determines whether the values of `unitsSel1` are greater than the values of `unitsSel2`. The final join operations match `chanAlias1` to the input of `unitsSel1` and match `chanAlias1` to the input of `unitsSel2`.

Example 7-1 Controlling Input-to-Source Matching With the `alias` Method

```
Source unitsSel = units.join(timeSel).join(custSel).join(prodSel);
Source chanAlias1 = chanHier.alias();
Source chanAlias2 = chanHier.alias();
NumberSource unitsSel1 = (NumberSource)
    unitsSel.join(chanAlias1.value());
NumberSource unitsSel2 = (NumberSource)
    unitsSel.join(chanAlias2.value());
Source result = unitsSel1.gt(unitsSel2)
    .join(chanAlias1) // Output 2, column
    .join(chanAlias2); // Output 1, row;
```

The result `Source` specifies the query, "Are the units sold values of `unitsSel1` for the channel values of `chanAlias1` greater than the units sold values of `unitsSel2` for the channel values of `chanAlias2`?" Because `result` is produced by the joining of `chanAlias2` to the `Source` produced by `unitsSel1.gt(unitsSel2).join(chanAlias1)`, `chanAlias2` is the first output of `result`, and `chanAlias1` is the second output of `result`.

A `Cursor` for the `result` `Source` has as its values the boolean values that answer the query. The values of the first output of the `Cursor` are the channel values specified by `chanAlias2` and the values of its second output are the channel values specified by `chanAlias1`.

The following is a display of the values of the `Cursor` formatted as a crosstab with headings added. The column edge values are the values from `chanAlias1`, and the row edge values are the values from `chanAlias2`. The values of the crosstab cells are the boolean values that indicate whether the units sold value for the column channel value is greater than the units sold value for the row channel value. For example, the crosstab values in the first column indicate that the units sold for the column channel value `All Channels` is not greater than the units sold for the row `All Channels` value but it is greater than the units sold for the `Direct Sales`, `Catalog`, and `Internet` row values.

	----- chanAlias1 -----			
chanAlias2	All Channels	Direct Sales	Catalog	Internet
All Channels	false	false	false	false
Direct Sales	true	false	true	false
Catalog	true	false	false	false
Internet	true	true	true	false

Using the `distinct` Method

You use the `distinct` method to produce a `Source` that does not have any duplicated values. [Example 7-2](#) selects an element from a hierarchy of the Customer dimension and gets the descendants of that element. It then appends the descendants to the hierarchy element selection. Because the `Source` for the descendants includes the ancestor value, the example uses the `distinct` method to remove the duplicated ancestor value, which would otherwise appear twice in the result.

In [Example 7-2](#), `mktRollup` is a `StringSource` that represents the Market Rollup hierarchy of the Customer dimension. The `mktRollupAncestors` object is the `Source` for the ancestors attribute of that hierarchy. To get a `Source` that represents the descendants of the ancestors, the example uses the `join` method to select, for each element of `mktRollupAncestors`, the elements of `mktRollup` that have the `mktRollupAncestors` element as their ancestor. The join operation matches the base `Source`, `mktRollup`, to the input of the ancestors attribute.

The resulting `Source`, `mktRollupDescendants`, however, still has `mktRollup` as an input because the `Source` produced by the `mktRollup.value()` method is the comparison `Source` of the join operation. The comparison parameter `Source` of a join operation does not participate in the matching of an input to a `Source`.

The `selectValue` method of `mktRollup` selects the element of `mktRollup` that has the value `MARKET_ROLLUP::ACCOUNT::23`, which is the Business World account, and produces `selVal`. The `join` method of `mktRollupDescendants` uses `selVal` as the comparison `Source`. The method produces `selValDescendants`, which has the elements of `mktRollupDescendants` that are present in `mktRollup`, and that are also in `selVal`. The input of `mktRollupDescendants` is matched by the joined `Source` `mktRollup`. The `mktRollup` `Source` is not an output of `selValDescendants` because the value of the `visible` parameter of the join operation is `false`.

The `appendValues` method of `selVal` produces `selValPlusDescendants`, which is the result of appending the elements of `selValDescendants` to the element of `selVal` and then removing any duplicate elements with the `distinct` method.

Example 7-2 Using the distinct Method

```
Source mktRollupDescendants =
    mktRollup.join(mktRollupAncestors, mktRollup.value());
Source selVal = mktRollup.selectValue("MARKET_ROLLUP::ACCOUNT::23");
Source selValDescendants = mktRollupDescendants.join(mktRollup,
    selVal,
    false);
Source selValPlusDescendants = selVal.appendValues(selValDescendants)
    .distinct();
```

A `Cursor` for the `selValPlusDescendants` `Source` has the following values:

```
MARKET_ROLLUP::ACCOUNT::23
MARKET_ROLLUP::SHIP_TO::51
MARKET_ROLLUP::SHIP_TO::52
MARKET_ROLLUP::SHIP_TO::53
MARKET_ROLLUP::SHIP_TO::54
```

If the example did not include the `distinct` method call, then a `Cursor` for `selValPlusDescendants` would have the following values:

```
MARKET_ROLLUP::ACCOUNT::23
MARKET_ROLLUP::ACCOUNT::23
MARKET_ROLLUP::SHIP_TO::51
MARKET_ROLLUP::SHIP_TO::52
MARKET_ROLLUP::SHIP_TO::53
MARKET_ROLLUP::SHIP_TO::54
```

Using the join Method

You use the `join` method to produce a `Source` that has the elements of its base `Source` that are determined by the `joined`, `comparison`, and `comparisonRule` parameters of the method. The `visible` parameter determines whether the `joined` `Source` is an output of the `Source` produced by the join operation. You also use the `join` method to match a `Source` to an input of the base or `joined` parameter `Source`.

The `join` method has many signatures that are convenient shortcuts for the full `join(Source joined, Source comparison, int comparisonRule, boolean visible)` method. The examples in this chapter use various `join` method signatures.

The `Source` class has several constants that you can provide as the value of the `comparisonRule` parameter. [Example 7-3](#) and [Example 7-4](#) demonstrate the use of two of those constants, `COMPARISON_RULE_REMOVE` and `COMPARISON_RULE_DESCENDING`. [Example 7-5](#) also uses `COMPARISON_RULE_REMOVE`.

[Example 7-3](#) produces a result similar to [Example 7-2](#). It uses `mktRollup`, which is the `Source` for a hierarchy of the `Customer` dimension, and `mktRollupAncestors`, which is the `Source` for the ancestors attribute for the hierarchy. It also uses `mktRollupDescendants`, which is a `Source` for the descendants of elements of the hierarchy.

The example first selects an element of the hierarchy. Next, the `join` method of `mktRollupDescendants` produces `mktRollupDescendantsOnly`, which specifies the descendants of `mktRollup`, and which has `mktRollup` as an input because the `comparison` parameter of the join operation is the `Source` that results from the `mktRollup.value()` method.

Because `COMPARISON_RULE_REMOVE` is the comparison rule of the join operation that produced `mktRollupDescendantsOnly`, a join operation that matches a `Source` to the input of `mktRollupDescendantsOnly` produces a `Source` that has only those elements of `mktRollupDescendantsOnly` that are not in the comparison `Source` of the join operation.

The next join operation performs such a match. It matches the `joined` `Source`, `mktRollup`, to the input of `mktRollupDescendantsOnly` to produce `selValDescendantsOnly`, which specifies the descendants of the selected hierarchy value but does not include the selected value because `mktRollupDescendantsOnly` specifies the removal of any values that match the value of the comparison `Source`, which is `selVal`.

As a contrast, the last join operation produces `selValDescendants`, which specifies the descendants of the selected hierarchy value and which does include the selected value.

Example 7-3 Using `COMPARISON_RULE_REMOVE`

```
Source selVal = mktRollup.selectValue("MARKET_ROLLUP::ACCOUNT::23");
Source mktRollupDescendantsOnly =
    mktRollupDescendants.join(mktRollupDescendants.getDataType().value(),
                            mktRollup.value(),
                            Source.COMPARISON_RULE_REMOVE);

// Select the descendants of the specified element.
Source selValDescendants = mktRollupDescendants.join(mktRollup, selVal);

// Select only the descendants of the specified element.
```

```
Source selValDescendantsOnly = mktRollupDescendantsOnly.join(mktRollup,
                                                         selVal);
```

A Cursor for `selValDescendants` has the following values.

```
MARKET_ROLLUP::ACCOUNT::23
MARKET_ROLLUP::SHIP_TO::51
MARKET_ROLLUP::SHIP_TO::52
MARKET_ROLLUP::SHIP_TO::53
MARKET_ROLLUP::SHIP_TO::54
```

A Cursor for `selValDescendantsOnly` has the following values.

```
MARKET_ROLLUP::SHIP_TO::51
MARKET_ROLLUP::SHIP_TO::52
MARKET_ROLLUP::SHIP_TO::53
MARKET_ROLLUP::SHIP_TO::54
```

Example 7-4 demonstrates another join operation, which uses the comparison rule `COMPARISON_RULE_DESCENDING`. It uses the following Source objects.

- `prodSelWithShortDescr`, which is the Source produced by joining the Source for the short value description attribute of the Product dimension to the Source for the FAMILY level of the Product Rollup hierarchy of that dimension.
- `unitPrice`, which is the Source for the Unit Price measure.
- `timeSelWithShortDescr`, which is the Source produced by joining the Source for the short value description attribute of the Time dimension to the Source for a selected element of the Calendar hierarchy of that dimension.

The resulting Source specifies the product family level elements in descending order of total unit prices for the month of May, 2001.

Example 7-4 Using COMPARISON_RULE_DESCENDING

```
Source result =
    prodSelWithShortDescr.join(unitPrice,
                              unitPrice.getDataType(),
                              Source.COMPARISON_RULE_DESCENDING,
                              true)
    .join(timeSelWithShortDescr);
```

A Cursor for the `result` Source has the following values, displayed as a table. The table includes only the short value descriptions of the dimension elements and the unit price values, and has formatting added.

May, 2001

Total Unit Prices	Product Family
-----	-----
8,536.77	Portable PCs
5,613.08	Desktop PCs
1,273.00	CD-ROM
830.74	Memory
795.24	Monitors
448.06	Documentation
364.93	Accessories
318.61	Modems/Fax
131.84	Operating Systems

Using the position Method

You use the `position` method to produce a `Source` that has the positions of the elements of its base and has the base as an input. [Example 7-5](#) uses the `position` method in producing a `Source` that specifies the selection of the first and last elements of the levels of a hierarchy of the Time dimension.

In the example, `mdmTimeDim` is the `MdmPrimaryDimension` for the Time dimension. The example gets the level attribute and the default hierarchy of the dimension. It then gets `Source` objects for the attribute and the hierarchy.

Next, the example creates an array of `Source` objects and gets a `List` of the `MdmLevel` components of the hierarchy. It gets the `Source` object for each level and adds it to the array, and then creates a list `Source` that has the `Source` objects for the levels as its element values.

The example then produces `levelMembers`, which is a `Source` that specifies the members of the levels of the hierarchy. Because the comparison parameter of the join operation is the `Source` produced by `levelList.value()`, `levelMembers` has `levelList` as an input. Therefore, `levelMembers` is a `Source` that returns the members of each level, by level, when its input is matched in a join operation.

The range `Source` specifies a range of elements from the second element to the next to last element of a `Source`.

The next join operation produces the `firstAndLast` `Source`. The base of the operation is `levelMembers`. The joined parameter is the `Source` that results from the `levelMembers.position()` method. The comparison parameter is the range `Source` and the comparison rule is `COMPARISON_RULE_REMOVE`. The value of the visible parameter is `true`. The `firstAndLast` `Source` therefore specifies only the first and last members of the levels because it removes all of the other members of the levels from the selection. The `firstAndLast` `Source` still has `levelList` as an input.

The final join operation matches the input of `firstAndLast` to `levelList`.

Example 7-5 *Selecting the First and Last Time Elements*

```
MdmAttribute mdmTimeLevelAttr = mdmTimeDim.getLevelAttribute();
MdmLevelHierarchy mdmTimeHier = (MdmLevelHierarchy)
    mdmTimeDim.getDefaultHierarchy();

Source levelRel = mdmTimeLevelAttr.getSource();
StringSource calendar = (StringSource) mdmTimeHier.getSource();

Source[] levelSources = new Source[3];
List levels = mdmTimeHier.getLevels();
for (int i = 0; i < levelSources.length; i++)
{
    levelSources[i] = ((MdmLevel) levels.get(i)).getSource();
}
Source levelList = dp.createListSource(levelSources);
Source levelMembers = calendar.join(levelRel, levelList.value());
Source range = dp.createRangeSource(2, levelMembers.count().minus(1));
Source firstAndLast = levelMembers.join(levelMembers.position(),
    range
    Source.COMPARISON_RULE_REMOVE,
    true);

Source result = firstAndLast.join(levelList);
```

A Cursor for the result Source has the following values, displayed as a table with column headings and formatting added. The left column names the level, the middle column is the position of the member in the level, and the right column is the local value of the member.

Level	Member Position in Level	Member Value
YEAR	1	1
YEAR	7	119
QUARTER	1	5
QUARTER	26	116
MONTH	1	19
MONTH	77	107

Using the recursiveJoin Method

You use the `recursiveJoin` method to produce a Source that has its elements ordered hierarchically. You use the `recursiveJoin` method only with the Source for an `MdmHierarchy` or with a subtype of such a Source. The method produces a Source whose elements are ordered hierarchically by the parents and their children in the hierarchy.

Like the `join` method, you use the `recursiveJoin` method to produce a Source that has the elements of its base Source that are determined by the `joined`, `comparison`, and `comparisonRule` parameters of the method. The `visible` parameter determines whether the `joined` Source is an output of the Source produced by the recursive join operation.

The `recursiveJoin` method has several signatures. The full `recursiveJoin` method has parameters that specify the parent attribute of the hierarchy, whether the result should have the parents before or after their children, how to order the elements of the result if the result includes children but not the parent, and whether the `joined` Source is an output of the resulting Source.

Example 7-6 uses a `recursiveJoin` method that lists the parents first, restricts the parents to the base, and does not add the `joined` Source as an output. The example first sorts the elements of a hierarchy of the Product dimension by hierarchical levels and then by the value of the color attribute of each element.

The first `recursiveJoin` method orders the elements of the `prodRollup` hierarchy in ascending hierarchical order. The `prodParent` object is the Source for the parent attribute of the hierarchy.

The `prodColorAttr` object in the second `recursiveJoin` method is the Source for a color attribute of the hierarchy. Only the elements of the Item level of the hierarchy have a related color value. Because the elements in the aggregate levels Total Product, Class, and Family, do not have related colors, the color attribute value for elements in those levels is `null`, which appears as `NA` in the results. Some of the Item level elements do not have a related color, so their values are `NA`, also.

The second `recursiveJoin` method joins the color attribute values to their related hierarchy elements and sorts the elements hierarchically by level, and then sorts them in ascending order in the level by the color value. The `COMPARISON_RULE_ASCENDING_NULLS_FIRST` parameter specifies that elements that have a null value appear before the other elements in the same level. The example then joins the result of the method, `sortedHierNullsFirst`, to the color attribute to produce a Source that has the color values as its element values and `sortedHierNullsFirst` as an output.

The third `recursiveJoin` method is the same as the second, except that the `COMPARISON_RULE_ASCENDING_NULLS_LAST` parameter specifies that elements that have a null value appear after the other elements in the same level.

Example 7-6 Sorting Products Hierarchically By Color

```
Source result1 =
    prodRollup.recursiveJoin(prodDim.value(),
                            prodRollup.getDataType(),
                            prodParent,
                            Source.COMPARISON_RULE_ASCENDING);

Source sortedHierNullsFirst =
    prodRollup.recursiveJoin(prodColorAttr,
                            prodColorAttr.getDataType(),
                            prodParent,
                            Source.COMPARISON_RULE_ASCENDING_NULLS_FIRST);

Source result2 = prodColorAttr.join(sortedHierNullsFirst);

Source sortedHierNullsLast =
    prodRollup.recursiveJoin(prodColorAttr,
                            prodColorAttr.getDataType(),
                            prodParent,
                            Source.COMPARISON_RULE_DESCENDING_NULLS_LAST);

Source result3 = prodColorAttr.join(sortedHierNullsLast);
```

A Cursor for the `result1` Source has the following values, displayed with a heading added. The list contains only the first ten values of the Cursor.

```
Product Dimension Element Value
-----
PRODUCT_ROLLUP::TOTAL_PRODUCT::1
PRODUCT_ROLLUP::CLASS::2
PRODUCT_ROLLUP::FAMILY::4
PRODUCT_ROLLUP::ITEM::13
PRODUCT_ROLLUP::ITEM::14
PRODUCT_ROLLUP::ITEM::15
PRODUCT_ROLLUP::FAMILY::5
PRODUCT_ROLLUP::ITEM::16
PRODUCT_ROLLUP::ITEM::17
PRODUCT_ROLLUP::ITEM::18
...
```

A Cursor for the `result2` Source has the following values, displayed as a table with headings added. The table contains only the first ten values of the Cursor. The left column has the member values of the hierarchy and the right column has the color attribute value for the member.

The Item level elements that have a null value appear first, and then the other level members appear in ascending order of color value. Since the data type of the color attribute is String, the color values are in ascending alphabetical order.

Product Dimension Element Value	Color Value
-----	-----
PRODUCT_ROLLUP::TOTAL_PRODUCT::1	NA
PRODUCT_ROLLUP::CLASS::2	NA
PRODUCT_ROLLUP::FAMILY::4	NA
PRODUCT_ROLLUP::ITEM::14	NA
PRODUCT_ROLLUP::ITEM::15	Black
PRODUCT_ROLLUP::ITEM::13	Silver
PRODUCT_ROLLUP::FAMILY::5	NA

```

PRODUCT_ROLLUP::ITEM::18      NA
PRODUCT_ROLLUP::ITEM::17      Beige
PRODUCT_ROLLUP::ITEM::16      Silver
...

```

A Cursor for the `result3` Source has the following values, displayed as a table with headings added. This time the members are in descending order, alphabetically by color attribute value.

Product Dimension Element Value	Color Value
PRODUCT_ROLLUP::TOTAL_PRODUCT::1	NA
PRODUCT_ROLLUP::CLASS::2	NA
PRODUCT_ROLLUP::FAMILY::4	NA
PRODUCT_ROLLUP::ITEM::14	NA
PRODUCT_ROLLUP::ITEM::13	Silver
PRODUCT_ROLLUP::ITEM::15	Black
PRODUCT_ROLLUP::FAMILY::5	NA
PRODUCT_ROLLUP::ITEM::18	NA
PRODUCT_ROLLUP::ITEM::16	Silver
PRODUCT_ROLLUP::ITEM::17	Beige
...	

Using the value Method

You use the value method to create a Source that has itself as an input. That relationship enables you to select a subset of elements of the Source.

Example 7-7 demonstrates the selection of such a subset. In the example, `shipRollup` is a Source for the `SHIPMENTS_ROLLUP` hierarchy of the Customer dimension. The `selectValues` method of `shipRollup` produces `custSel`, which is a selection of some of the elements of `shipRollup`. The `selectValues` method of `custSel` produces `custSel2`, which is a subset of that selection.

The first `join` method has `custSel` as the base and as the joined Source. It has `custSel2` as the comparison Source. The elements of the resulting Source, `result1`, are one set of the elements of `custSel` for each element of `custSel` that is in the comparison Source. The `true` value of the `visible` parameter causes the joined Source to be an output of `result1`.

The second `join` method also has `custSel` as the base and `custSel2` as the comparison Source, but it has the result of the `custSel.value()` method as the joined Source. Because `custSel` is an input of the joined Source, the base Source matches that input. That input relationship causes the resulting Source, `result2`, to have only those elements of `custSel` that are also in the comparison Source.

Example 7-7 Selecting a Subset of the Elements of a Source

```

StringSource custSel = (StringSource) shipRollup.selectValues(new String[]
    {"SHIPMENTS_ROLLUP::SHIP_TO::60",
     "SHIPMENTS_ROLLUP::SHIP_TO::61",
     "SHIPMENTS_ROLLUP::SHIP_TO::62",
     "SHIPMENTS_ROLLUP::SHIP_TO::63"});

Source custSel2 = custSel.selectValues(new String[]
    {"SHIPMENTS_ROLLUP::SHIP_TO::60",
     "SHIPMENTS_ROLLUP::SHIP_TO::62"});

Source result1 = custSel.join(custSel, custSel2, true);

```



```
Source result2 = custSel.join(custSel.value(), custSel2, true);
```

A Cursor for result1 has the following values, displayed as a table with headings added. The left column has the values of the elements of the output of the Cursor. The right column has the values of the Cursor.

Output Value	result1 Value
SHIPMENTS_ROLLUP::SHIP_TO::60	SHIPMENTS_ROLLUP::SHIP_TO::60
SHIPMENTS_ROLLUP::SHIP_TO::60	SHIPMENTS_ROLLUP::SHIP_TO::61
SHIPMENTS_ROLLUP::SHIP_TO::60	SHIPMENTS_ROLLUP::SHIP_TO::62
SHIPMENTS_ROLLUP::SHIP_TO::60	SHIPMENTS_ROLLUP::SHIP_TO::63
SHIPMENTS_ROLLUP::SHIP_TO::62	SHIPMENTS_ROLLUP::SHIP_TO::60
SHIPMENTS_ROLLUP::SHIP_TO::62	SHIPMENTS_ROLLUP::SHIP_TO::61
SHIPMENTS_ROLLUP::SHIP_TO::62	SHIPMENTS_ROLLUP::SHIP_TO::62
SHIPMENTS_ROLLUP::SHIP_TO::62	SHIPMENTS_ROLLUP::SHIP_TO::63

A Cursor for result2 has the following values, displayed as a table with headings added. The left column has the values of the elements of the output of the Cursor. The right column has the values of the Cursor.

Output Value	result2 Value
SHIPMENTS_ROLLUP::SHIP_TO::60	SHIPMENTS_ROLLUP::SHIP_TO::60
SHIPMENTS_ROLLUP::SHIP_TO::62	SHIPMENTS_ROLLUP::SHIP_TO::62

Using Other Source Methods

Along with the methods that are various signatures of the basic methods, the Source class has many other methods that use combinations of the basic methods. Some methods perform selections based on a single position, such as the `at` and `offset` methods. Others operate on a range of positions, such as the `interval` method. Some perform comparisons, such as `eq` and `gt`, select one or more elements, such as `selectValue` or `removeValue`, or sort elements, such as `sortAscending` or `sortDescendingHierarchically`.

The subclasses of Source each have other specialized methods, also. For example, the NumberSource class has many methods that perform mathematical functions such as `abs`, `div`, and `cos`, and methods that perform aggregations, such as `average` and `total`.

Some of the Source methods are implemented as CustomModel objects. For example, the `extract` method, which used to be a basic Source method, now uses a CustomModel, as shown in [Example 6-11](#) in [Chapter 6, "Understanding Source Objects"](#). The current implementation of the `extract` method produces the same result as the previous implementation.

This section has examples that demonstrate the use of some of the Source methods. Some of the examples are tasks that an OLAP application typically performs.

Using the extract Method

You use the `extract` method to extract the values of a Source that has Source objects as its element values. If the elements of a Source have element values that are not Source objects, the `extract` method operates like the `value` method.

[Example 7-8](#) uses the `extract` method to get the values of the NumberSource objects that are themselves the values of the elements of `measDim`. Each of the NumberSource objects represents a measure. The first two are the primary

NumberSource objects for the Units and the Unit Price measures, and the third is a NumberSource derived from a mathematical operation on the primary NumberSource objects.

The example selects values from hierarchies of the dimensions of the NumberSource for the Units measure. Two of the dimensions are the dimensions of the NumberSource for the Unit Price measure. The example produces `sales`, which is the result of the `times` method of `units` with `unitPrice` as the `rhs` parameter of the method.

Next, the example creates a list Source, `measDim`, which has the three NumberSource objects as its element values. It then uses the `extract` method to get the values of the NumberSource objects. The resulting unnamed Source has `measDim` as an extraction input. The input is matched by first join operation, which has `measDim` as the `joined` parameter. The example then matches the other inputs of the measures by joining the dimension selections to produce the `result` Source.

Example 7-8 Using the extract Method

```
Source prodSel = prodHier.selectValues(new String[]
    { "PRODUCT_ROLLUP::ITEM::13",
      "PRODUCT_ROLLUP::ITEM::14",
      "PRODUCT_ROLLUP::ITEM::15"});
Source chanSel = chanHier.selectValue("CHANNEL_ROLLUP::CHANNEL::2");
Source timeSel = timeHier.selectValue("CALENDAR::MONTH::59");
Source custSel = custHier.selectValue("SHIPMENTS_ROLLUP::ALL_CUSTOMERS::1");

Source sales = units.times(unitPrice);

Source measDim = dp.createListSource(new Source[]
    {units, unitPrice, sales});

Source result = measDim.extract().join(measDim) // column
    .join(prodSel) // row
    .join(timeSel) // page
    .join(chanSel) // page
    .join(custSel); // page
```

The following crosstab displays the values of a Cursor for the `result` Source, with headings and formatting added.

```
SHIPMENTS_ROLLUP::ALL_CUSTOMERS::1
CHANNEL_ROLLUP::CHANNEL::2
CALENDAR::MONTH::59
```

ITEM	UNITS SOLD	TOTAL OF UNIT PRICES	SALES AMOUNT
13	39	2,395.63	93,429.57
14	37	3,147.85	116,470.45
15	26	2,993.29	77,825.54

Creating a Cube and Pivoting Edges

One typical OLAP operation is the creation of a cube, which is a multi-dimensional array of data. The data of the cube is specified by the elements of the column, row, and page edges of the cube. The data of the cube can be data from a measure that is specified by the elements of the dimensions of the measure. The cube data can also be dimension elements that are specified by some calculation of the measure data, such as products that have unit sales quantities greater than a specified amount.

Most of the examples in this section create cubes. [Example 7-9](#) creates a cube that has the quantity of units sold as its data. The column edge values are initially from a channel dimension hierarchy, the row edge values are from a time dimension hierarchy, and the page edge values of the cube are from elements of hierarchies for product and customer dimensions. The product and customer elements on the page edge are represented by parameterized `Source` objects.

The example joins the selections of the dimension elements to the short value description attributes for the dimensions so that the results have more information than just the numerical identifications of the dimension values. It then joins the `Source` objects derived from the dimensions to the `Source` for the measure to produce the cube query. It prepares and commits the current `Transaction`, and then creates a `Cursor` for the query and displays its values.

After displaying the values of the `Cursor`, the example changes the value of the `Parameter` for the parameterized `Source` for the customer selection, thereby retrieving a different result set using the same `Cursor` in the same `Transaction`. The example resets the position of the `Cursor`, and displays the values of the `Cursor` again.

The example then pivots the column and row edges so that the column values are time elements and the row values are channel elements. It prepares and commits the `Transaction`, creates another `Cursor` for the query, and displays its values. It then changes the value of each `Parameter` object and displays the values of the `Cursor` again.

The `dp` object is the `DataProvider`. The context object has a method that displays the values of the `Cursor` in a crosstab format.

Example 7-9 Creating a Cube and Pivoting Its Edges

```
// Create Parameter objects with values from the default hierarchies
// of the Customer and Product dimensions.
StringParameter custParam =
    new StringParameter(dp, "SHIPMENTS_ROLLUP::REGION::9");
StringParameter prodParam =
    new StringParameter(dp, "PRODUCT_ROLLUP::FAMILY::4");

// Create parameterized Source objects using the Parameter objects.
StringSource custParamSrc = dp.createParameterizedSource(custParam);
StringSource prodParamSrc = dp.createParameterizedSource(prodParam);

// Select single values from the hierarchies, using the Parameter
// objects as the comparisons in the join operations.
Source paramCustSel = custHier.join(custHier.value(), custParamSrc);
Source paramProdSel = prodHier.join(prodHier.value(), prodParamSrc);

// Select elements from the other dimensions of the measure
Source timeSel = timeHier.selectValues(new String[]
    {"CALENDAR::YEAR::2",
     "CALENDAR::YEAR::3",
     "CALENDAR::YEAR::4"});
Source chanSel = chanHier.selectValues(new String[]
    {"CHANNEL_ROLLUP::CHANNEL::2",
     "CHANNEL_ROLLUP::CHANNEL::3",
     "CHANNEL_ROLLUP::CHANNEL::4"});

// Join the dimension selections to the short description attributes
// for the dimensions.
Source columnEdge = chanSel.join(chanShortDescr);
```

```
Source rowEdge = timeSel.join(timeShortDescr);
Source page1 = paramProdSel.join(prodShortDescr);
Source page2 = paramCustSel.join(custShortDescr);

// Join the dimension selections to the measure.
Source cube = units.join(columnEdge)
               .join(rowEdge)
               .join(page2)
               .join(page1);

// Get the TransactionProvider.
TransactionProvider tp = context.getTransactionProvider();
// Prepare and commit the currentTransaction.
try
{
    tp.prepareCurrentTransaction();
}
catch(NotCommittableException e)
{
    context.println("Cannot prepare the current Transaction. " + e
)
}
tp.commitCurrentTransaction();

// Create a Cursor for the query.
CursorManagerSpecification cMngrSpec =
    dp.createCursorManagerSpecification(cube);
SpecifiedCursorManager spCMngr = dp.createCursorManager(cMngrSpec);
Cursor cubeCursor = spCMngr.createCursor();
// Display the values of the Cursor as a Crosstab.
context.displayCursorAsCrosstab(cubeCursor);

// Change the customer parameter value.
custParam.setValue("SHIPMENTS_ROLLUP::REGION::10");

// Reset the Cursor position to 1 and display its values again.
cubeCursor.setPosition(1);
context.println(" ");
context.displayCursorAsCrosstab(cubeCursor);

// Pivot the column and row edges.
columnEdge = timeSel.join(timeShortDescr);
rowEdge = chanSel.join(chanShortDescr);

// Join the dimension selections to the measure.
cube = units.join(columnEdge)
               .join(rowEdge)
               .join(page2)
               .join(page1);

// Prepare and commit the current Transaction.
try
{
    tp.prepareCurrentTransaction();
}
catch(NotCommittableException e)
{
    context.println("Cannot prepare the current Transaction. " + e);
}
tp.commitCurrentTransaction();
```

```
// Create another Cursor.
cMngrSpec = dp.createCursorManagerSpecification(cube);
spCMngr = dp.createCursorManager(cMngrSpec);
cubeCursor = spCMngr.createCursor();
context.displayCursorAsCrosstab(cubeCursor);

// Change the product parameter value.
prodParam.setValue("PRODUCT_ROLLUP::FAMILY::5");

// Reset the Cursor position to 1
cubeCursor.setPosition(1);
context.println(" ");
context.displayCursorAsCrosstab(cubeCursor);
```

The following crosstab has the values of cubeCursor displayed by the first displayCursorAsCrosstab method.

```
Portable PCs
Europe

          Direct Sales  Catalog  Internet
1999                86    1986         0
2000                193    1777         10
2001                196    1449        215
```

The following crosstab has the values of cubeCursor after the example changed the value of the custParam Parameter object.

```
Portable PCs
North America

          Direct Sales  Catalog  Internet
1999                385    6841         0
2000                622    6457         35
2001                696    5472        846
```

The next crosstab has the values of cubeCursor after pivoting the column and row edges.

```
Portable PCs
North America

          1999    2000    2001
Direct Sales    385    622    696
Catalog         6841   6457   5472
Internet         0      35    846
```

The last crosstab has the values of cubeCursor after changing the value of the prodParam Parameter object.

```
Desktop PCs
North America

          1999    2000    2001
Direct Sales    793    1224   1319
Catalog        14057   1321  11337
Internet         0      69    1748
```

Drilling Up and Down in a Hierarchy

Drilling up or down in a dimension hierarchy is another typical OLAP operation. [Example 7–10](#) demonstrates getting the elements of one level of a dimension hierarchy, selecting an element, and then getting the parent, children, and ancestors of the element.

The example uses the following objects.

- `levelSrc`, which is the `Source` for the Family level of the Product Rollup hierarchy of the Product dimension.
- `prodRollup`, which is the `Source` for the Product Rollup hierarchy.
- `prodRollupParentAttr`, which is the `Source` for the parent attribute of the hierarchy.
- `prodRollupAncsAttr`, which is the `Source` for the ancestors attribute of the hierarchy.
- `prodShortLabel`, which is the `Source` for the short value description attribute of the Product dimension.
- `context`, which has methods that prepare and commit the current `Transaction`, that create a `Cursor` for a `Source`, that display text, and that display the values of the `Cursor`.

Example 7–10 *Drilling in a Hierarchy*

```
int pos = 5;
// Get the element at the specified position of the level Source.
Source levelElement = levelSrc.at(pos);

// Select the element of the hierarchy with the specified value.
Source levelSel = prodRollup.join(prodRollup.value(), levelElement);

// Get ancestors of the level element.
Source levelElementAncs = prodRollupAncsAttr.join(prodRollup,
                                                levelElement);

// Get the parent of the level element.
Source levelElementParent = prodRollupParentAttr.join(prodRollup,
                                                    levelElement);

// Get the children of a parent.
Source prodRollupChildren = prodRollup.join(prodRollupParentAttr,
                                           prodRollup.value());

// Select the children of the level element.
Source levelElementChildren = prodRollupChildren.join(prodRollup,
                                                    levelElement);

// Get the short value descriptions for the elements of the level.
Source levelSrcWithShortDescr = prodShortLabel.join(levelSrc);

// Get the short value descriptions for the children.
Source levelElementChildrenWithShortDescr =
    prodShortLabel.join(levelElementChildren);

// Get the short value descriptions for the parents.
Source levelElementParentWithShortDescr =
    prodShortLabel.join(prodRollup, levelElementParent, true);
```

```
// Get the short value descriptions the ancestors.
Source levelElementAncsWithShortDescr =
    prodShortLabel.join(prodRollup, levelElementAncs, true);

// Prepare and commit the current Transaction.
context.commit();

// Create Cursor objects and display their values.
context.println("Level element values:");
context.displayResult(levelSrcWithShortDescr);
context.println("\nLevel element at position " + pos + ":");
context.displayResult(levelElement);
context.println("\nParent of the level element:");
context.displayResult(levelElementParent);
context.println("\nChildren of the level element:");
context.displayResult(levelElementChildrenWithShortDescr);
context.println("\nAncestors of the level element:");
context.displayResult(levelElementAncs);
```

The following list has the values of the Cursor objects created by the `displayResults` methods.

Level element values:

```
1: (PRODUCT_ROLLUP::FAMILY::10,Memory)
2: (PRODUCT_ROLLUP::FAMILY::11,CD-ROM)
3: (PRODUCT_ROLLUP::FAMILY::12,Documentation)
4: (PRODUCT_ROLLUP::FAMILY::4,Portable PCs)
5: (PRODUCT_ROLLUP::FAMILY::5,Desktop PCs)
6: (PRODUCT_ROLLUP::FAMILY::6,Operating Systems)
7: (PRODUCT_ROLLUP::FAMILY::7,Accessories)
8: (PRODUCT_ROLLUP::FAMILY::8,Monitors)
9: (PRODUCT_ROLLUP::FAMILY::9,Modems/Fax)
```

Level element at position 5:

```
1: PRODUCT_ROLLUP::FAMILY::5
```

Parent of the level element:

```
1: (PRODUCT_ROLLUP::CLASS::2,Hardware)
```

Children of the level element:

```
1: (PRODUCT_ROLLUP::ITEM::16,Sentinel Standard)
2: (PRODUCT_ROLLUP::ITEM::17,Sentinel Financial)
3: (PRODUCT_ROLLUP::ITEM::18,Sentinel Multimedia)
```

Ancestors of the level element:

```
1: (PRODUCT_ROLLUP::TOTAL_PRODUCT::1,Total Product)
2: (PRODUCT_ROLLUP::CLASS::2,Hardware)
3: (PRODUCT_ROLLUP::FAMILY::5,Desktop PCs)
```

Sorting Hierarchically by Measure Values

[Example 7-11](#) uses the `recursiveJoin` method to sort the elements of the Product Rollup hierarchy of the Product dimension hierarchically in ascending order of the values of the Units measure. The example joins the sorted products to the short value

description attribute of the dimension, and then joins the result of that operation, `sortedProductsShortDescr`, to `units`.

The successive `joinHidden` methods join the selections of the other dimensions of `units` to produce the `result` `Source`, which has the measure data as its element values and `sortedProductsShortDescr` as its output. The example uses the `joinHidden` methods so that the other dimension selections are not outputs of the result.

The example uses the following objects.

- `prodRollup`, which is the `Source` for the Product Rollup hierarchy.
- `units`, which is the `Source` for the UNITS measure of product units sold.
- `prodParent`, which is the `Source` for the parent attribute of the Product Rollup hierarchy.
- `prodShortDescr`, which is the `Source` for the short value description attribute of the Product dimension.
- `custSel`, which is a `Source` that specifies a single element of the default hierarchy of the Customer dimension. Its value is `SHIPMENTS_ROLLUP : : ALL_CUSTOMERS : : 1`, which is all customers.
- `chanSel`, which is a `Source` that specifies a single element of the default hierarchy of the Channel dimension. Its value is `CHANNEL_ROLLUP : : CHANNEL : : 2`, which is the direct sales channel.
- `timeSel`, which is a `Source` that specifies a single element of the default hierarchy of the Time dimension. Its value is `CALENDAR : : YEAR : : 4`, which is the year 2001.

Example 7–11 Hierarchical Sorting by Measure Value

```
Source sortedProduct =
    prodRollup.recursiveJoin(units,
                            units.getDataType(),
                            prodParent,
                            Source.COMPARISON_RULE_ASCENDING,
                            true, // Parents first
                            true); // Restrict parents to base

Source sortedProductShortDescr = prodShortDescr.join(sortedProduct);
Source result = units.join(sortedProductShortDescr)
                .joinHidden(custSel)
                .joinHidden(chanSel)
                .joinHidden(timeSel);
```

A `Cursor` for the `result` `Source` has the following values, displayed in a table with column headings and formatting added. The left column has the name of the level in the `PRODUCT_ROLLUP` hierarchy. The next column to the right has the product identification value, and the next column has the short value description of the product. The rightmost column has the number of units of the product sold to all customers in the year 2001 through the direct sales channel.

The table contains only the first nine and the last ten values of the `Cursor`, plus the `Software/Other` class value. The product values are listed in hierarchical order by units sold. The `Hardware` class appears before the `Software/Other` class because the `Software/Other` class has a greater number of units sold. In the `Hardware` class, the `Monitors` family sold the fewest units, so it appears first. In the `Software/Other` class, the `Accessories` family has the greatest number of units sold, so it appears last.

Product Level	ID	Description	Units Sold
-----	-	-----	-----
TOTAL_PRODUCT	1	Total Product	43,783
CLASS	2	Hardware	16,541
FAMILY	4	Portable PCs	1,192
ITEM	15	Envoy Ambassador	330
ITEM	14	Envoy Executive	385
ITEM	13	Envoy Standard	477
FAMILY	8	Monitors	1,193
ITEM	21	Monitor- 19 Super VGA	207
ITEM	20	Monitor- 15 Super VGA	986
...			
CLASS	3	Software/Other	27,242
...			
FAMILY	7	Accessories	18,949
ITEM	22	Envoy External Keyboard	146
ITEM	23	External 101-key keyboard	678
ITEM	32	Multimedia speakers- 5 cones	717
ITEM	46	Standard Mouse	868
ITEM	27	Multimedia speakers- 3 cones	1,120
ITEM	31	1.44MB External 3.5 Diskette	1,145
ITEM	48	Keyboard Wrist Rest	2,231
ITEM	19	Laptop carrying case	3,704
ITEM	47	Deluxe Mouse	3,884
ITEM	30	Mouse Pad	4,456

Using NumberSource Methods To Compute the Share of Units Sold

[Example 7-12](#) uses the NumberSource methods `div` and `times` to produce a Source that specifies the share that the Desktop PC and Portable PC families have of the total quantity of product units sold for the selected time, customer, and channel values. The example first uses the `selectValue` method of `prodRollup`, which is the Source for a hierarchy of the Product dimension, to produce `allProds`, which specifies a single element with the value `PRODUCT_ROLLUP::TOTAL_PRODUCT::1`, which is the highest aggregate level of the hierarchy.

The `joinHidden` method of the NumberSource `units` produces `totalUnits`, which specifies the Units measure values at the total product level, without having `allProds` appear as an output of `totalUnits`. The `div` method of `units` then produces a Source that represents each units sold value divided by total quantity of units sold. The `times` method then multiplies the result of that `div` operation by 100 to produce `productShare`, which represents the percentage, or share, that a product element has of the total quantity of units sold. The `productShare` Source has the inputs of the `units` measure as its inputs.

The `prodFamilies` object is the Source for the Family level of the Product Rollup hierarchy. The `join` method of `productShare`, with `prodFamilies` as the joined Source, produces a Source that specifies the share that each product family has of the total quantity of products sold.

The `custSel`, `chanSel`, and `timeSel` Source objects are selections of single elements of hierarchies of the Customer, Channel, and Time dimensions. The remaining `join` methods match those Source objects to the other inputs of `productShare`, to produce `result`. The `join(Source joined, String comparison)` signature of the `join` method produces a Source that does not have the joined Source as an output.

The `result` Source specifies the share for each product family of the total quantity of products sold to all customers through the direct sales channel in the year 2001.

Example 7–12 Getting the Share of Units Sold

```
Source allProds = prodRollup.selectValue("PRODUCT_ROLLUP::TOTAL_PRODUCT::1");
NumberSource totalUnits = (NumberSource) units.joinHidden(allProds);
Source productShare = units.div(totalUnits).times(100);
Source result =
    productShare.join(prodFamilies)
                .join(timeHier, "CALENDAR::YEAR::4")
                .join(chanHier, "CHANNEL_ROLLUP::CHANNEL::2")
                .join(custHier, "SHIPMENTS_ROLLUP::ALL_CUSTOMERS::1");
```

A Cursor for the `result` Source has the following values, displayed in a table with column headings and formatting added. The left column has the product family value and the right column has the share of the total number of units sold for the product family to all customers through the direct sales channel in the year 2001.

Product Family Element	Share of Total Units Sold
PRODUCT_ROLLUP::FAMILY::10	3.57%
PRODUCT_ROLLUP::FAMILY::11	11.71%
PRODUCT_ROLLUP::FAMILY::12	6.4%
PRODUCT_ROLLUP::FAMILY::4	2.72%
PRODUCT_ROLLUP::FAMILY::5	5.13%
PRODUCT_ROLLUP::FAMILY::6	12.54%
PRODUCT_ROLLUP::FAMILY::7	43.28%
PRODUCT_ROLLUP::FAMILY::8	2.73%
PRODUCT_ROLLUP::FAMILY::9	11.92%

Ranking Dimension Elements by Measure Value

[Example 7–13](#) produces two results. The first is `result1`, which is a Source that specifies the rank of two families of products and their members in the order of the sales of all product units. The second is `result2`, which ranks those families and their members by quantity of units sold compared to each other.

The `units` object is the Source for the Units measure, and `prodRollup` is the Source for the Product Rollup hierarchy of the Product dimension. The `join` method of `units` produces a Source that specifies units sold values for each element of the hierarchy.

The `select` method has as its `filter` parameter the BooleanSource produced by the `gt` method of the Source that results from the `units.value()` method. The Source that results from the `select` method has `units` as an input. When a join operation matches a Source to that input, it produces a Source that, for each element of the `units` measure, has the Boolean value `true` for every units sold value that is greater than the current element value.

The `count` method then produces a Source that has, for each element of the measure, the total number of all the products that have greater sales quantities. The product element with the greatest quantity of units sold therefore has a count of zero. The `plus` method then adds 1 to each count amount so that the rank values begin with the number 1.

The `join` method of the Source produced by the `plus` method selects the elements of `pcParentsAndChildren` from all of the elements of the product hierarchy. The `joinHidden` methods then match Source objects that specify selections of the dimensions that are the remaining inputs of the `units` measure to produce `result1`,

which specifies the calculation of the rank of the selected product elements relative to all of the product elements for the customer, time, and channel values.

The methods that product result2 are the same except that the first join produces a Source that specifies the units elements only for the elements of pcParentsAndChildren. The select, gt, count, and plus methods operate on only those selected elements of the hierarchy. The result2 Source therefore specifies the calculation of the rank of the selected product elements relative to each other rather than relative to all product elements.

Example 7-13 Ranking Products by Units Sold

```
// First result: PC products unit sales ranked relative to all products.
Source result1 = units.join(prodRollup,
    dp.getEmptySource(),
    Source.COMPARISON_RULE_REMOVE,
    false)
    .select(units.value().gt(units)).count().plus(1)
    .join(pcParentsAndChildren)
    .joinHidden(custSel)
    .joinHidden(timeSel)
    .joinHidden(chanSel);

// Second result: PC products unit sales ranked relative to each other.
Source result2 = units.join(pcParentsAndChildren,
    dp.getEmptySource(),
    Source.COMPARISON_RULE_REMOVE,
    false)
    .select(units.value().gt(units)).count().plus(1)
    .join(prodRollup)
    .joinHidden(custSel)
    .joinHidden(timeSel)
    .joinHidden(chanSel);
```

A Cursor for the result1 Source has the following values, displayed in a table with column headings and formatting added. The left column has the product element value and the right column has the rank of that product compared to all product units sold.

Product Element	Rank Compared To Total Products Sold
-----	-----
PRODUCT_ROLLUP::FAMILY::5	16
PRODUCT_ROLLUP::FAMILY::4	21
PRODUCT_ROLLUP::ITEM::16	29
PRODUCT_ROLLUP::ITEM::17	31
PRODUCT_ROLLUP::ITEM::18	34
PRODUCT_ROLLUP::ITEM::13	35
PRODUCT_ROLLUP::ITEM::14	37
PRODUCT_ROLLUP::ITEM::15	39

A Cursor for the result2 Source has the following values, displayed in a table with column headings and formatting added. The left column has the product element value and the right column has the rank of that product compared to the other product family members.

Product Element	Rank Compared To Each Other
-----	-----
PRODUCT_ROLLUP::FAMILY::5	1
PRODUCT_ROLLUP::FAMILY::4	2
PRODUCT_ROLLUP::ITEM::16	3
PRODUCT_ROLLUP::ITEM::17	4
PRODUCT_ROLLUP::ITEM::18	5
PRODUCT_ROLLUP::ITEM::13	6
PRODUCT_ROLLUP::ITEM::14	7
PRODUCT_ROLLUP::ITEM::15	8

Selecting Based on Time Series Operations

This section has two examples of using methods that operate on a series of time dimension elements. [Example 7–14](#) uses the `lag` method of `unitPrice`, which is the Source for the Unit Price measure, to produce `unitPriceLag4`, which specifies, for each element of `unitPrice`, the element of `unitPrice` that is four time periods before it at the same time dimension level.

In the example, `dp` is the `DataProvider`. Its `createListSource` method creates `measuresDim`, which has the `unitPrice` and `unitPriceLag4` Source objects as its element values. The `extract` method of `measuresDim` gets the values of the elements of `measuresDim`. The Source produced by the `extract` method has `measuresDim` as an extraction input. The first `join` method matches a Source, `measuresDim`, to the input of the Source produced by the `extract` method.

The `unitPrice` and `unitPriceLag4` measures both have the Product and Time dimensions as inputs. The second `join` method matches `quarterLevel`, which is a Source for the Quarter level of the Calendar hierarchy of the Time dimension, to the measure input for the Time dimension, and makes it an output of the resulting Source.

The `joinHidden` method matches `prodSel` to the measure input for the Product dimension, and does not make `prodSel` an output of the resulting Source. The `prodSel` Source specifies the single hierarchy element `PRODUCT_ROLLUP::FAMILY::5`, which is Desktop PCs.

The `lagResult` Source specifies the aggregate unit prices for each quarter and the aggregate unit prices for the quarter four quarters earlier for the Desktop PC product family.

Example 7–14 Using the Lag Method

```
NumberSource unitPriceLag4 = unitPrice.lag(mdmTimeHier, 4);
Source measuresDim = dp.createListSource(new Source[] {unitPrice,
                                                    unitPriceLag4});

Source lagResult = measuresDim.extract()
    .join(measuresDim)
    .join(quarterLevel)
    .joinHidden(prodSel);
```

A Cursor for the `lagResult` Source has the following values, displayed in a table with column headings and formatting added. The left column has the quarter, the middle column has the total of the unit prices for the members of the Desktop PC family for that quarter, and the left column has the total of the unit prices for the quarter four quarters earlier. The first four values in the right column are NA because

quarter 5, Q1-98, is the first quarter in the Calendar hierarchy. The table includes only the first eight quarters.

Quarter	Unit Price	
	Unit Price	Four Quarters Before
-----	-----	-----
CALENDAR::QUARTER::5	16125.24	NA
CALENDAR::QUARTER::6	16226.89	NA
CALENDAR::QUARTER::7	16039.61	NA
CALENDAR::QUARTER::8	15526.53	NA
CALENDAR::QUARTER::9	21553.14	16,125.24
CALENDAR::QUARTER::10	21034.61	162,26.89
CALENDAR::QUARTER::11	21135.51	16,039.61
CALENDAR::QUARTER::12	19600.98	15,526.53
...		

Example 7-15 uses the same `unitPrice`, `quarterLevel`, and `prodSel` objects as **Example 7-14**, but it uses the `unitPriceMovingTotal` measure as the second element of `measuresDim`. The `unitPriceMovingTotal` Source is produced by the `movingTotal` method of `unitPrice`. That method provides `mdmTimeHier`, which is an `MdmLevelHierarchy` component of the Time dimension, as its dimension parameter and the integers 0 and 3 as the starting and ending offset values.

The `movingTotalResult` Source specifies, for each quarter, the aggregate of the unit prices for the members of the Desktop PC family for that quarter and the total of that unit price plus the unit prices for the next three quarters.

Example 7-15 Using the movingTotal Method

```
NumberSource unitPriceMovingTotal =
    unitPrice.movingTotal(mdmTimeHier, 0, 3);

Source measuresDim = dp.createListSource(new Source[]
    {unitPrice,
     unitPriceMovingTotal});

Source movingTotalResult = measuresDim.extract()
    .join(measuresDim)
    .join(quarterLevel)
    .joinHidden(prodSel);
```

A Cursor for the `movingTotalResult` Source has the following values, displayed in a table with column headings and formatting added. The left column has the quarter, the middle column has the total of the unit prices for the members of the Desktop PC family for that quarter, and the right column has the total of the unit prices for that quarter and the next three quarters. The table includes only the first eight quarters.

Quarter	Unit Price Moving Total	
	Unit Price	Current Plus Next Three Periods
-----	-----	-----
CALENDAR::QUARTER::5	16,125.24	63,918.27
CALENDAR::QUARTER::6	16,226.89	69,346.17
CALENDAR::QUARTER::7	16,039.61	74,153.89
CALENDAR::QUARTER::8	15,526.53	79,249.79
CALENDAR::QUARTER::9	21,553.14	83,324.24
CALENDAR::QUARTER::10	21,034.61	80,206.84
CALENDAR::QUARTER::11	21,135.51	77,638.28
...		

Selecting a Set of Elements Using Parameterized Source Objects

Example 7–16 uses `NumberParameter` objects to create parameterized `Source` objects. Those objects are the bottom and top parameters for the `interval` method of `prodRollup`. That method produces `paramProdSelInterval`, which is a `Source` that specifies the set of elements of `prodRollup` from the bottom to the top positions of the hierarchy.

The product elements specify the elements of the `units` measure that appear in the result `Source`. By changing the values of the `Parameter` objects, you can select a different set of units sold values using the same `Cursor` and without having to produce new `Source` and `Cursor` objects.

The example uses the following objects.

- `dp`, which is the `DataProvider` for the session.
- `prodRollup`, which is the `Source` for the Product Rollup hierarchy of the Product dimension.
- `prodShortDescr`, which is the `Source` for the short value description attribute of the Product dimension.
- `units`, which is the `Source` for the Units measure of product units sold.
- `chanRollup`, which is the `Source` for the Channel Rollup hierarchy of the Channel dimension.
- `calendar`, which is the `Source` for the Calendar hierarchy of the Time dimension.
- `shipRollup`, which is the `Source` for the Shipments Rollup hierarchy of the Customer dimension.
- `context`, which has methods that prepare and commit the current `Transaction`, that create a `Cursor` for a `Source`, that display text, and that display the values of the `Cursor`.

The `join` method of `prodShortDescr` gets the short value descriptions for the elements of `paramProdSelInterval`. The next four `join` methods match `Source` objects to the inputs of the `units` measure. The example creates a `Cursor` and displays the result set of the query. Next, the `setPosition` method of `resultCursor` sets the position of the `Cursor` back to its first element.

The `setValue` methods of the `NumberParameter` objects change the values of those objects, which changes the selection of product elements specified by the query. The example then displays the values of the `Cursor` again.

Example 7–16 *Selecting a Range With NumberParameter Objects*

```
NumberParameter startParam = new NumberParameter(dp, 1);
NumberParameter endParam = new NumberParameter(dp, 6);

NumberSource startParamSrc = dp.createParameterizedSource(startParam);
NumberSource endParamSrc = dp.createParameterizedSource(endParam);

Source paramProdSelInterval = prodRollup.interval(startParamSrc,
                                                endParamSrc);

Source paramProdSelIntervalShortDescr =
    prodShortDescr.join(paramProdSelInterval);
```

```

NumberSource result = (NumberSource)
    units.join(chanRollup, "CHANNEL_ROLLUP::CHANNEL::4")
        .join(calendar, "CALENDAR::YEAR::4")
        .join(shipRollup,
            "SHIPMENTS_ROLLUP::ALL_CUSTOMERS::1")
        .join(paramProdSelIntervalShortDescr);

// Get the TransactionProvider and prepare and commit the
// current transaction. These operations are not shown.

CursorManagerSpecification cMngrSpec =
    dp.createCursorManagerSpecification(results);
SpecifiedCursorManager spCMngr = dp.createCursorManager(cMngrSpec);
Cursor resultCursor = spCMngr.createCursor();

context.displayCursor(resultCursor);

//Reset the Cursor position to 1;
resultCursor.setPosition(1);

// Change the value of the parameterized Source
startParam.setValue(7);
endParam.setValue(12);

// Display the results again.
context.displayCursor(resultsCursor);

```

The following table displays the values of `resultCursor`, with column headings and formatting added. The left column has the product hierarchy elements, the middle column has the short value description, and the right column has the quantity of units sold.

Product	Description	Units Sold
PRODUCT_ROLLUP::TOTAL_PRODUCT::1	Total Product	55,872
PRODUCT_ROLLUP::CLASS::2	Hardware	21,301
PRODUCT_ROLLUP::FAMILY::4	Portable PCs	1,420
PRODUCT_ROLLUP::ITEM::13	Envoy Standard	550
PRODUCT_ROLLUP::ITEM::14	Envoy Executive	482
PRODUCT_ROLLUP::ITEM::15	Envoy Ambassador	388
PRODUCT_ROLLUP::FAMILY::5	Desktop PCs	2,982
PRODUCT_ROLLUP::ITEM::16	Sentinel Standard	1,092
PRODUCT_ROLLUP::ITEM::17	Sentinel Financial	1,015
PRODUCT_ROLLUP::ITEM::18	Sentinel Multimedia	875
PRODUCT_ROLLUP::FAMILY::8	Monitors	1,505
PRODUCT_ROLLUP::ITEM::20	Monitor- 15 Super VGA	1,238

Using a TransactionProvider

This chapter describes the Oracle OLAP API `Transaction` and `TransactionProvider` interfaces and describes how you use implementations of those interfaces in an application. You must create a `TransactionProvider` before you can create a `DataProvider`, and you must use methods of the `TransactionProvider` to prepare and commit a `Transaction` before you can create a `Cursor` for a derived `Source`.

This chapter includes the following topics:

- [About Creating a Query in a Transaction](#)
- [Using TransactionProvider Objects](#)

For the complete code for the examples in this chapter, see the example programs available from the Overview of the *Oracle OLAP Java API Reference*.

About Creating a Query in a Transaction

The Oracle OLAP API is transactional. Each step in creating a query occurs in the context of a `Transaction`. One of the first actions of an OLAP API application is to create a `TransactionProvider`. The `TransactionProvider` provides `Transaction` objects to the application.

The `TransactionProvider` ensures the following:

- A `Transaction` is isolated from other `Transaction` objects. Operations performed in a `Transaction` are not visible in, and do not affect, other `Transaction` objects.
- If an operation in a `Transaction` fails, its effects are undone (the `Transaction` is rolled back).
- The effects of a completed `Transaction` persist.

When you create a derived `Source` by calling a method of another `Source`, the derived `Source` is created in the context of the *current* `Transaction`. The `Source` is *active* in the `Transaction` in which you create it or in a child `Transaction` of that `Transaction`.

You get or set the current `Transaction`, or begin a child `Transaction`, by calling methods of a `TransactionProvider`. In a child `Transaction` you can alter the query, for example by changing the selection of dimension elements or by performing a different mathematical or analytical operation on the data, which changes the state of a `Template` that you created in the parent `Transaction`. By displaying the data specified by the `Source` produced by the `Template` in the parent `Transaction` and also displaying the data specified by the `Source` produced by the `Template` in the

child Transaction, you can provide the end user of your application with the means of easily altering a query and viewing the results of different operations on the same set of data, or the same operations on different sets of data.

Types of Transaction Objects

The OLAP API has the following two types of Transaction objects:

- A read Transaction. Initially, the current Transaction is a read Transaction. A read Transaction is required for creating a Cursor to fetch data from Oracle OLAP. For more information on Cursor objects, see [Chapter 10](#).
- A write Transaction. A write Transaction is required for creating a derived Source or for changing the state of a Template. For more information on creating a derived Source, see [Chapter 6](#). For information on Template objects, see [Chapter 11](#).

In the initial read Transaction, if you create a derived Source or if you change the state of a Template object, then a child write Transaction is automatically generated. That child Transaction becomes the current Transaction.

If you then create another derived Source or change the Template state again, that operation occurs in the same write Transaction. You can create any number of derived Source objects, or make any number of Template state changes, in that same write Transaction. You can use those Source objects, or the Source produced by the Template, to define a complex query.

Before you can create a Cursor to fetch the result set specified by a derived Source, you must move the Source from the child write Transaction into the parent read Transaction. To do so, you prepare and commit the Transaction.

Preparing and Committing a Transaction

To move a Source that you created in a child Transaction into the parent read Transaction, call the `prepareCurrentTransaction` and `commitCurrentTransaction` methods of the `TransactionProvider`. When you commit a child write Transaction, a Source you created in the child Transaction moves into the parent read Transaction. The child Transaction disappears and the parent Transaction becomes the current Transaction. The Source is active in the current read Transaction and you can therefore create a Cursor for it.

The following figure illustrates the process of moving a Source created in a child write Transaction into its parent read Transaction.

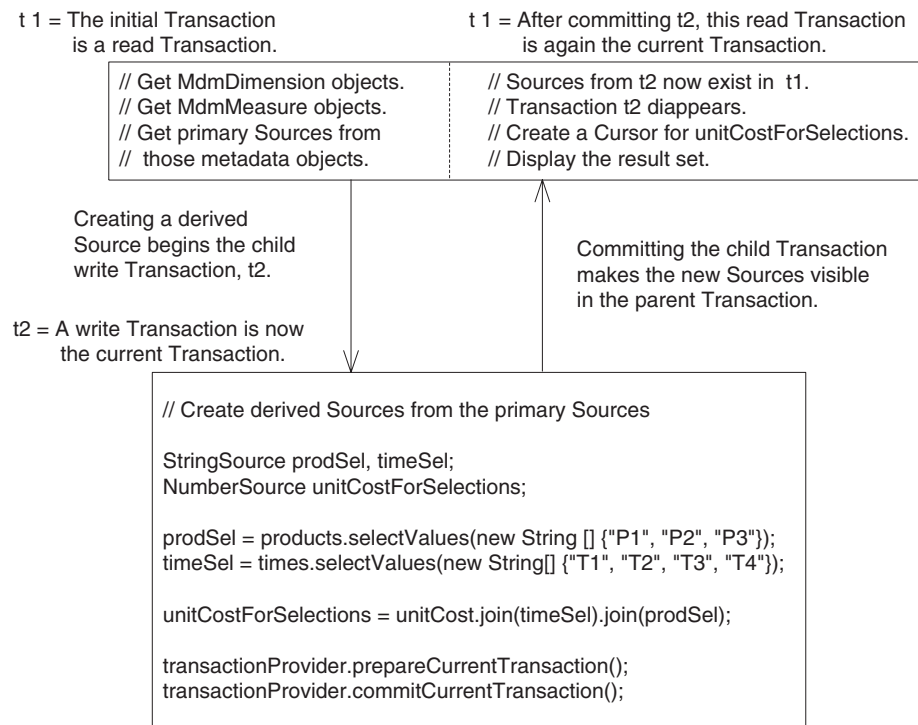
Figure 8–1 Committing a Write Transaction into Its Parent Read Transaction

About Transaction and Template Objects

Getting and setting the current Transaction, beginning a child Transaction, and rolling back a Transaction are operations that you use to allow an end user to make different selections starting from a given state of a dynamic query.

To present the end user with alternatives based on the same initial query, you do the following:

1. Create a Template in a parent Transaction and set the initial state for the Template.
2. Get the Source produced by the Template, create a Cursor to retrieve the result set, get the values from the Cursor, and then display the results to the end user.
3. Begin a child Transaction and modify the state of the Template.
4. Get the Source produced by the Template in the child Transaction, create a Cursor, get the values, and display them.

You can then replace the first Template state with the second one or discard the second one and retain the first.

Beginning a Child Transaction

To begin a child read Transaction, call the `beginSubtransaction` method of the `TransactionProvider` you are using. In the child read Transaction, if you change the state of a Template, then a child write Transaction begins automatically. The write Transaction is a child of the child read Transaction.

To get the data specified by the Source produced by the Template, you prepare and commit the write Transaction into its parent read Transaction. You can then create a Cursor to fetch the data. The changed state of the Template is not visible in

the original parent. The changed state does not become visible in the parent until you prepare and commit the child read Transaction into the parent read Transaction.

The following figure illustrates beginning a child read Transaction, creating Source objects in a write Transaction, and committing the write Transaction into its parent read Transaction. The figure then shows committing the child read Transaction into its parent read Transaction. In the figure, tp is the TransactionProvider.

Figure 8–2 Committing a Child Read Transaction into Its Parent Transaction

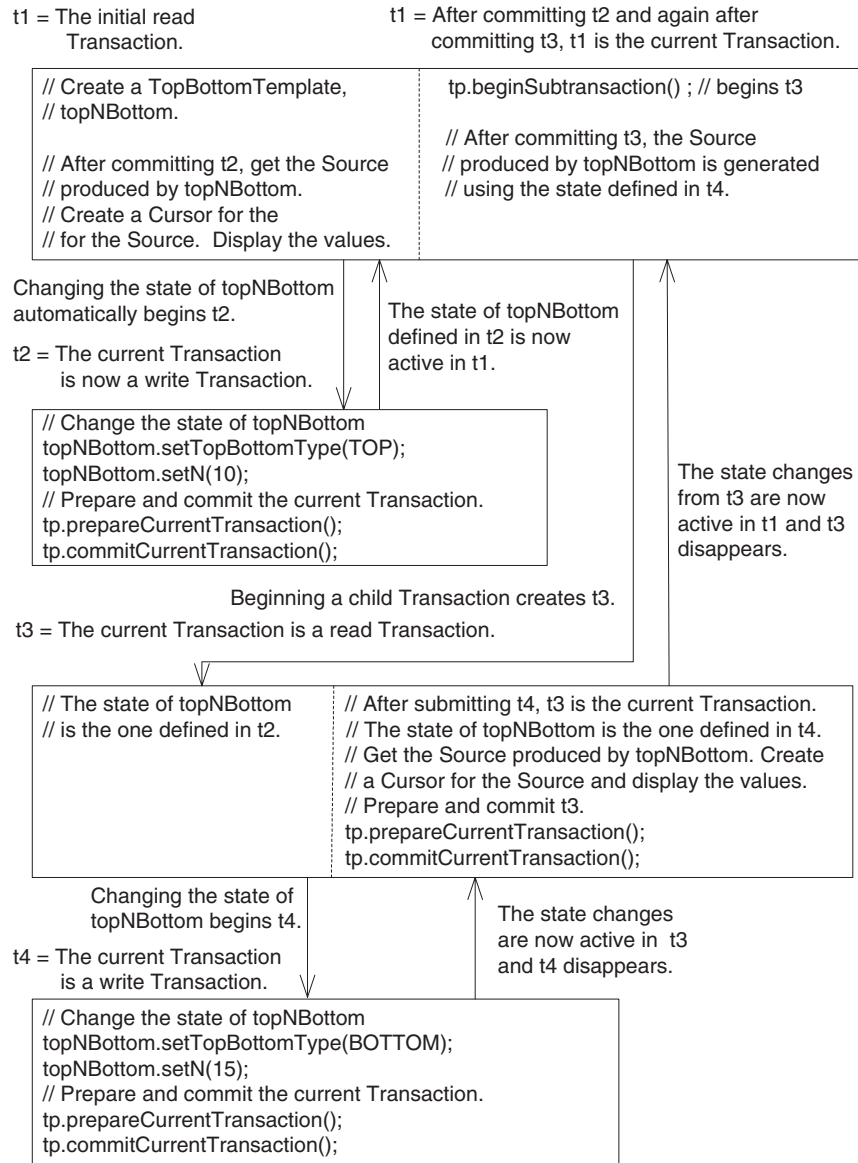

After beginning a child read Transaction, you can begin a child read Transaction of that child, or a grandchild of the initial parent Transaction. For an example of creating child and grandchild Transaction objects, see [Example 8–2](#).

About Rolling Back a Transaction

You roll back, or undo, a Transaction by calling the `rollbackCurrentTransaction` method of the `TransactionProvider` you are using. Rolling back a Transaction discards any changes that you made during that Transaction and makes the Transaction disappear.

Before rolling back a Transaction, you must close any `CursorManager` objects you created in that Transaction. After rolling back a Transaction, any `Source` objects that you created or `Template` state changes that you made in the Transaction are no longer valid. Any `Cursor` objects you created for those `Source` objects are also invalid.

Once you roll back a Transaction, you cannot prepare and commit that Transaction. Likewise, once you commit a Transaction, you cannot roll it back.

Example 8–1 Rolling Back a Transaction

The following example uses the `TopBottomTemplate` and `SingleSelectionTemplate` classes that are described in [Chapter 11, "Creating Dynamic Queries"](#). In creating the `TopBottomTemplate` and `SingleSelectionTemplate` objects, the example uses the same code that appears in [Example 11–4, "Getting the Source Produced by the Template"](#). [Example 8–1](#) does not show that code. This example sets the state of the `TopBottomTemplate`. It begins a child Transaction that sets a different state for the `TopBottomTemplate` and then rolls back the child Transaction. The `TransactionProvider` is `tp` and context is an object that has methods that create `Cursor` objects and display their values.

```
// The current Transaction is a read Transaction, t1.
// Create a TopBottomTemplate using a hierarchy of the Product dimension
// as the base and dp as the DataProvider.
TopBottomTemplate topNBottom = new TopBottomTemplate(prodRollup, dp);

// Changing the state of a Template requires a write Transaction, so a
// write child Transaction, t2, is automatically started.
topNBottom.setTopBottomType(TopBottomTemplate.TOP_BOTTOM_TYPE_TOP);
topNBottom.setN(10);
topNBottom.setCriterion(singleSelections.getSource());

// Prepare and commit the Transaction t2.
try
{
    tp.prepareCurrentTransaction();
}
catch(NotCommittableException e)
{
    context.println("Cannot commit the Transaction. " + e);
}
tp.commitCurrentTransaction();           //t2 disappears

// The current Transaction is now t1.
// Get the dynamic Source produced by the TopBottomTemplate.
Source result = topNBottom.getSource();

// Create a Cursor and display the results (these operations are
// performed by the context object).
context.println("\nThe current state of the TopBottomTemplate\n" +
               "produces the following values:\n");
context.displayTopBottomResult(result);
```

```

// Start a child Transaction, t3. It is a read Transaction.
tp.beginSubtransaction();           // t3 is the current Transaction

// Change the state of topNBottom. Changing the state requires a
// write Transaction so Transaction t4 starts automatically,
topNBottom.setTopBottomType(TopBottomTemplate.TOP_BOTTOM_TYPE_BOTTOM);
topNBottom.setN(15);

// Prepare and commit the Transaction.
try
{
    tp.prepareCurrentTransaction();
}
catch(NotCommittableException e)
{
    context.println("Cannot commit the Transaction. " + e);
}
tp.commitCurrentTransaction();     // t4 disappears

// Create a Cursor and display the results. // t3 is the current Transaction
context.println("\nIn the child Transaction, the state of the\n" +
               "TopBottomTemplate produces the following values:\n");
context.displayTopBottomResult(result);
// The displayTopBottomResult method closes the CursorManager for the
// Cursor created in t3.

// Undo t3, which discards the state of topNBottom that was set in t4.
tp.rollbackCurrentTransaction();   // t3 disappears

// Transaction t1 is now the current Transaction and the state of
// topNBottom is the one defined in t2.

// To show the current state of the TopNBottom template Source,
// prepare and commit the Transaction, create a Cursor, and display
// its values.
try
{
    tp.prepareCurrentTransaction();
}
catch(NotCommittableException e)
{
    context.println("Cannot commit the Transaction. " + e);
}
tp.commitCurrentTransaction();

context.println("\nAfter rolling back the child Transaction, the state "
+ "of\nthe TopBottomTemplate produces the following "
+ "values:\n");
context.displayTopBottomResult(result);

```

Example 8-1 produces the following output.

The current state of the TopBottomTemplate produces the following values:

1. PRODUCT_ROLLUP::TOTAL_PRODUCT::1
2. PRODUCT_ROLLUP::CLASS::3
3. PRODUCT_ROLLUP::FAMILY::7
4. PRODUCT_ROLLUP::CLASS::2
5. PRODUCT_ROLLUP::FAMILY::9

6. PRODUCT_ROLLUP::FAMILY::6
7. PRODUCT_ROLLUP::FAMILY::11
8. PRODUCT_ROLLUP::ITEM::30
9. PRODUCT_ROLLUP::ITEM::28
10. PRODUCT_ROLLUP::ITEM::47

In the child Transaction, the state of the TopBottomTemplate produces the following values:

1. PRODUCT_ROLLUP::ITEM::36
2. PRODUCT_ROLLUP::ITEM::43
3. PRODUCT_ROLLUP::ITEM::44
4. PRODUCT_ROLLUP::ITEM::38
5. PRODUCT_ROLLUP::ITEM::22
6. PRODUCT_ROLLUP::ITEM::21
7. PRODUCT_ROLLUP::ITEM::42
8. PRODUCT_ROLLUP::ITEM::41
9. PRODUCT_ROLLUP::ITEM::15
10. PRODUCT_ROLLUP::ITEM::34
11. PRODUCT_ROLLUP::ITEM::14
12. PRODUCT_ROLLUP::ITEM::45
13. PRODUCT_ROLLUP::ITEM::13
14. PRODUCT_ROLLUP::ITEM::26
15. PRODUCT_ROLLUP::ITEM::18

After rolling back the child Transaction, the state of the TopBottomTemplate produces the following values:

1. PRODUCT_ROLLUP::TOTAL_PRODUCT::1
2. PRODUCT_ROLLUP::CLASS::3
3. PRODUCT_ROLLUP::FAMILY::7
4. PRODUCT_ROLLUP::CLASS::2
5. PRODUCT_ROLLUP::FAMILY::9
6. PRODUCT_ROLLUP::FAMILY::6
7. PRODUCT_ROLLUP::FAMILY::11
8. PRODUCT_ROLLUP::ITEM::30
9. PRODUCT_ROLLUP::ITEM::28
10. PRODUCT_ROLLUP::ITEM::47

Getting and Setting the Current Transaction

You get the current Transaction by calling the `getCurrentTransaction` method of the TransactionProvider you are using, as in the following example.

```
Transaction t1 = getCurrentTransaction();
```

To make a previously saved Transaction the current Transaction, you call the `setCurrentTransaction` method of the TransactionProvider, as in the following example.

```
setCurrentTransaction(t1);
```

Using TransactionProvider Objects

In the Oracle OLAP API, the TransactionProvider interface is implemented by the ExpressTransactionProvider concrete class. Before you create a DataProvider, you must create a new instance of an ExpressTransactionProvider. You then pass that TransactionProvider to

the `DataProvider` constructor. The `TransactionProvider` provides `Transaction` objects to your application.

As described in ["Preparing and Committing a Transaction"](#), you use the `prepareCurrentTransaction` and `commitCurrentTransaction` methods to make a derived `Source` that you created in a child write `Transaction` visible in the parent read `Transaction`. You can then create a `Cursor` for that `Source`.

If you are using `Template` objects in your application, then you might also use the other methods of `TransactionProvider` to do the following:

- Begin a child `Transaction`.
- Get the current `Transaction` so you can save it.
- Set the current `Transaction` to a previously saved one.
- Rollback, or undo, the current `Transaction`, which discards any changes made in the `Transaction`. Once a `Transaction` has been rolled back, it is invalid and cannot be committed. Once a `Transaction` has been committed, it cannot be rolled back. If you created a `Cursor` for a `Source` in a `Transaction`, you must close the `CursorManager` before rolling back the `Transaction`.

[Example 8-2](#) demonstrates the use of `Transaction` objects to modify dynamic queries. Like [Example 8-1](#), this example uses the same code to create `TopBottomTemplate` and `SingleSelectionTemplate` objects as does [Example 11-4, "Getting the Source Produced by the Template"](#). This example does not show that code.

To help track the `Transaction` objects, this example saves the different `Transaction` objects with calls to the `getCurrentTransaction` method. In the example, `tp` object is the `TransactionProvider`, and `context` is an object that has methods that create `Cursor` objects and display their values.

Example 8-2 Using Child Transaction Objects

```
// The parent Transaction is the current Transaction at this point.
// Save the parent read Transaction as parentT1.
Transaction parentT1 = tp.getCurrentTransaction();

// Get the dynamic Source produced by the TopBottomTemplate.
Source result = topNBottom.getSource();

// Create a Cursor and display the results (these operations are
// performed by the context object).
context.println("\nThe current state of the TopBottomTemplate\n" +
               "produces the following values:\n");
context.displayTopBottomResult(result);

// Begin a child Transaction of parentT1.
tp.beginSubtransaction(); // This is a read Transaction.

// Save the child read Transaction as childT2.
Transaction childT2 = tp.getCurrentTransaction();

// Change the state of the TopBottomTemplate. This starts a
// write Transaction, a child of the read Transaction childT2.
topNBottom.setN(12);
topNBottom.setTopBottomType(TopBottomTemplate.TOP_BOTTOM_TYPE_BOTTOM);

// Save the child write Transaction as writeT3.
Transaction writeT3 = tp.getCurrentTransaction();
```



```
// Prepare and commit the write Transaction writeT3.
try
{
    tp.prepareCurrentTransaction();
}
catch(NotCommittableException e)
{
    context.println("Cannot commit current Transaction. " + e);
}
tp.commitCurrentTransaction();

// The commit moves the changes made in writeT3 into its parent,
// the read Transaction childT2. The writeT3 Transaction
// disappears. The current Transaction is now childT2
// again but the state of the TopBottomTemplate has changed.

// Create a Cursor and display the results of the changes to the
// TopBottomTemplate that are visible in childT2.
try
{
    context.println("\nIn the child Transaction, the state of the\n" +
        "TopBottomTemplate produces the following values:\n");

    context.displayTopBottomResult(result);
}
catch(Exception e)
{
    context.println("Cannot display the results of the query. " + e);
}

// Begin a grandchild Transaction of the initial parent.
tp.beginSubtransaction(); // This is a read Transaction.

// Save the grandchild read Transaction as grandchildT4.
Transaction grandchildT4 = tp.getCurrentTransaction();

// Change the state of the TopBottomTemplate. This starts another
// write Transaction, a child of grandchildT4.
topNBottom.setTopBottomType(TopBottomTemplate.TOP_BOTTOM_TYPE_TOP);

// Save the write Transaction as writeT5.
Transaction writeT5 = tp.getCurrentTransaction();

// Prepare and commit writeT5.
try
{
    tp.prepareCurrentTransaction();
}
catch(NotCommittableException e)
{
    context.println("Cannot commit current Transaction. " + e);
}
tp.commitCurrentTransaction();

// Transaction grandchildT4 is now the current Transaction and the
// changes made to the TopBottomTemplate state are visible.
```

```
// Create a Cursor and display the results visible in grandchildT4.
try
{
    context.println("\nIn the grandchild Transaction, the state of the\n" +
        "TopBottomTemplate produces the following values:\n");
    context.displayTopBottomResult(result);
}
catch(Exception e)
{
    context.println("Cannot display the results of the query. " + e);
}

// Commit the grandchild into the child.
try
{
    tp.prepareCurrentTransaction();
}
catch(NotCommittableException e)
{
    context.println("Cannot commit current Transaction. " + e);
}
tp.commitCurrentTransaction();

// Transaction childT2 is now the current Transaction.
// Instead of preparing and committing the grandchild Transaction,
// you could rollback the Transaction, as in the following
// method call:
//    rollbackCurrentTransaction();
// If you roll back the grandchild Transaction, then the changes
// you made to the TopBottomTemplate state in the grandchild
// are discarded and childT2 is the current Transaction.

// Commit the child into the parent.
try
{
    tp.prepareCurrentTransaction();
}
catch(NotCommittableException e)
{
    context.println("Cannot commit the child Transaction. " + e);
}
tp.commitCurrentTransaction();

// Transaction parentT1 is now the current Transaction. Again,
// you can roll back the childT2 Transaction instead of
// preparing and committing it. If you do so, then the changes
// you made in childT2 are discarded. The current Transaction
// is be parentT1, which has the original state of
// the TopBottomTemplate, without any of the changes made in
// the grandchild or the child transactions.
```

Example 8-2 produces the following output.

The current state of the TopBottomTemplate produces the following values:

1. PRODUCT_ROLLUP::TOTAL_PRODUCT::1
2. PRODUCT_ROLLUP::CLASS::3
3. PRODUCT_ROLLUP::FAMILY::7
4. PRODUCT_ROLLUP::CLASS::2

5. PRODUCT_ROLLUP::FAMILY::9
6. PRODUCT_ROLLUP::FAMILY::6
7. PRODUCT_ROLLUP::FAMILY::11
8. PRODUCT_ROLLUP::ITEM::30
9. PRODUCT_ROLLUP::ITEM::28
10. PRODUCT_ROLLUP::ITEM::47

In the child Transaction, the state of the TopBottomTemplate produces the following values:

1. PRODUCT_ROLLUP::ITEM::36
2. PRODUCT_ROLLUP::ITEM::43
3. PRODUCT_ROLLUP::ITEM::44
4. PRODUCT_ROLLUP::ITEM::38
5. PRODUCT_ROLLUP::ITEM::22
6. PRODUCT_ROLLUP::ITEM::21
7. PRODUCT_ROLLUP::ITEM::42
8. PRODUCT_ROLLUP::ITEM::41
9. PRODUCT_ROLLUP::ITEM::15
10. PRODUCT_ROLLUP::ITEM::34
11. PRODUCT_ROLLUP::ITEM::14
12. PRODUCT_ROLLUP::ITEM::45

In the grandchild Transaction, the state of the TopBottomTemplate produces the following values:

1. PRODUCT_ROLLUP::TOTAL_PRODUCT::1
2. PRODUCT_ROLLUP::CLASS::3
3. PRODUCT_ROLLUP::FAMILY::7
4. PRODUCT_ROLLUP::CLASS::2
5. PRODUCT_ROLLUP::FAMILY::9
6. PRODUCT_ROLLUP::FAMILY::6
7. PRODUCT_ROLLUP::FAMILY::11
8. PRODUCT_ROLLUP::ITEM::30
9. PRODUCT_ROLLUP::ITEM::28
10. PRODUCT_ROLLUP::ITEM::47
11. PRODUCT_ROLLUP::ITEM::19
12. PRODUCT_ROLLUP::ITEM::24

Understanding Cursor Classes and Concepts

This chapter describes the Oracle OLAP API `Cursor` class and its related classes, which you use to retrieve the results of a query. This chapter also describes the `Cursor` concepts of position, fetch size, and extent. For examples of creating and using a `Cursor` and its related objects, see [Chapter 10, "Retrieving Query Results"](#).

This chapter includes the following topics:

- [Overview of the OLAP API Cursor Objects](#)
- [Cursor Classes](#)
- [CursorManagerSpecification Class](#)
- [CursorInfoSpecification Classes](#)
- [CursorManager Classes](#)
- [Other Classes](#)
- [About Cursor Positions and Extent](#)
- [About Fetch Sizes](#)

For the complete code of the examples in this chapter, see the example programs available from the Overview of the *Oracle OLAP Java API Reference*.

Overview of the OLAP API Cursor Objects

A `Cursor` retrieves the result set defined by a `Source`. You can also get the SQL generated for a `Source` by the Oracle OLAP SQL generator without having to create a `Cursor`.

To get the SQL for the `Source`, you create an `ExpressSQLCursorManager` by using the `createSQLCursorManager` method of a `DataProvider`. You can then use classes outside of the OLAP API to retrieve data using the generated SQL.

The Oracle OLAP API has two paths to the creation of a `Cursor` for a `Source`. The older method requires creating a `CursorManagerSpecification`, then creating a `CursorManager`, and then creating a `Cursor`. The newer method eliminates the `CursorManagerSpecification`. Instead, you simply create a `CursorManager` for the `Source` and then create a `Cursor`.

Creating a Cursor Using a CursorManagerSpecification

In the older method, after creating a *Source* that defines the data that you want to retrieve from the data store, you create a *Cursor* for that *Source* by doing the following:

1. Creating a *CursorManagerSpecification* by passing the *Source* to the `createCursorManagerSpecification` method of the *DataProvider* that you are using. The *CursorManagerSpecification* has *CursorSpecification* objects in a structure that mirrors the structure of the *Source*.
2. Creating a *CursorManager* by calling the `createCursorManager` method of the *DataProvider* and passing it the *CursorManagerSpecification*. The *CursorManager* creates *Cursor* objects. It also manages the local data cache for its *Cursor* objects and is aware of changes to the *Source* for a dynamic query or a parameterized *Source*. If the *Source* for the *CursorManagerSpecification* has inputs, then you must also pass to the `createCursorManager` method an array of *Source* objects for those inputs.
3. Creating a *Cursor* by calling the `createCursor` method of the *CursorManager*. The structure of the *Cursor* mirrors the structures of the *CursorManagerSpecification* and the *Source*. The *CursorSpecification* objects of a *CursorManagerSpecification* specify the behavior of their corresponding *Cursor* objects. If the *Source* for the *CursorManagerSpecification* has inputs, then you must also pass to the `createCursor` method an array of *CursorInput* objects that specify values for the input *Source* objects.

For an example of creating a *Cursor* using this method, see [Chapter 10](#).

This architecture provides great flexibility in fetching data from a result set and in selecting data to display. You can do the following:

- Create more than one *CursorManagerSpecification* object for the same *Source*. You can specify different behavior on the *CursorSpecification* components of the various *CursorManagerSpecification* objects in order to retrieve and display different sets of values from the same result set. You might want to do this when displaying the data from a *Source* in different formats, such as in a table and a crosstab.
- Receive notification that the *Source* produced by the *Template* has changed. If you add a *CursorManagerUpdateListener* to the *CursorManager* for a *Source*, then the *CursorManagerUpdateListener* notifies the *CursorManagerUpdateListener* when the *Source* for a dynamic query has changed and you that therefore need to update the *CursorManagerSpecification* for the *CursorManager*.
- Update the *CursorManagerSpecification* for a *CursorManager*. If you are using *Template* objects to produce a dynamic query and the state of a *Template* changes, then the *Source* produced by the *Template* changes. If you have created a *Cursor* for the *Source* produced by the *Template*, then you need to replace the *CursorManagerSpecification* for the *CursorManager* with an updated *CursorManagerSpecification* for the changed *Source*. You can then create a new *Cursor* from the *CursorManager*.
- Create different *Cursor* objects from the same *CursorManager* and set different fetch sizes on those *Cursor* objects. You might do this when you want to display the same data as a table and as a graph.

This older method of creating a `CursorManager` returns an `ExpressSpecifiedCursorManager`.

Creating a Cursor Without a CursorManagerSpecification

In the newer method, you create a `Cursor` for a `Source` by doing the following:

1. Creating a `CursorManager` by calling one of the `createCursorManager` methods of the `DataProvider` and passing it the `Source`. If you want to alter the behavior of the `Cursor`, then you can create a `CursorInfoSpecification` and use its methods to specify the behavior. You then create a `CursorManager` with a method that takes the `Source` and the `CursorInfoSpecification`.
2. Creating a `Cursor` by calling the `createCursor` method of the `CursorManager`.

This newer method of creating a `CursorManager` returns an `ExpressDataCursorManager`.

Sources For Which You Cannot Create a Cursor

Some `Source` objects do not specify data that a `Cursor` can retrieve from the data store. The following are `Source` objects for which you cannot create a `Cursor`.

- A `Source` that specifies an operation that is not computationally possible. An example is a `Source` that specifies an infinite recursion.
- A `Source` that defines an infinite result set. An example is the fundamental `Source` that represents the set of all `String` objects.
- A `Source` that has no elements or includes another `Source` that has no elements. Examples are a `Source` returned by the `getEmptySource` method of `DataProvider` and another `Source` derived from the empty `Source`. Another example is a derived `Source` that results from selecting a value from a primary `Source` that you got from an `MdmDimension` and the selected value does not exist in the dimension.

Cursor Objects and Transaction Objects

When you create a derived `Source` or change the state of a `Template`, you create the `Source` in the context of the current `Transaction`. The `Source` is active in the `Transaction` in which you create it or in a child `Transaction` of that `Transaction`. A `Source` must be active in the current `Transaction` for you to be able to create a `Cursor` for it.

Creating a derived `Source` occurs in a write `Transaction`. Creating a `Cursor` occurs in a read `Transaction`. After creating a derived `Source`, and before you can create a `Cursor` for that `Source`, you must change the write `Transaction` into a read `Transaction` by calling the `prepareCurrentTransaction` and `commitCurrentTransaction` methods of the `TransactionProvider` your application is using. For information on `Transaction` and `TransactionProvider` objects, see [Chapter 8, "Using a TransactionProvider"](#).

For a `Cursor` that you create for a query that includes a parameterized `Source`, you can change the value of the `Parameter` object and then get the new values of the `Cursor` without having to prepare and commit the `Transaction` again. For information on parameterized `Source` objects, see [Chapter 6, "Understanding Source Objects"](#).

Cursor Classes

In the `oracle.olapi.data.cursor` package, the Oracle OLAP API defines the interfaces described in the following table.

Interface	Description
<code>Cursor</code>	An abstract superclass that encapsulates the notion of a current position.
<code>ValueCursor</code>	A <code>Cursor</code> that has a value at the current position. A <code>ValueCursor</code> has no child <code>Cursor</code> objects.
<code>CompoundCursor</code>	A <code>Cursor</code> that has child <code>Cursor</code> objects, which are a child <code>ValueCursor</code> for the values of its <code>Source</code> and an output child <code>Cursor</code> for each output of the <code>Source</code> .

Structure of a Cursor

The structure of a `Cursor` mirrors the structure of its `Source`. If the `Source` does not have any outputs, then the `Cursor` for that `Source` is a `ValueCursor`. If the `Source` has one or more outputs, then the `Cursor` for that `Source` is a `CompoundCursor`. A `CompoundCursor` has as children a base `ValueCursor`, which has the values of the base of the `Source` of the `CompoundCursor`, and one or more output `Cursor` objects.

The output of a `Source` is another `Source`. An output `Source` can itself have outputs. The child `Cursor` for an output of a `Source` is a `ValueCursor` if the output `Source` does not have any outputs and a `CompoundCursor` if it does.

[Example 9–1](#) creates a query that specifies the prices of selected product items for selected months. In the example, `timeHier` is a `Source` for a hierarchy of a dimension of time values, and `prodHier` is a `Source` for a hierarchy of a dimension of product values.

If you create a `Cursor` for `prodSel` or for `timeSel`, then either `Cursor` is a `ValueCursor` because both `prodSel` and `timeSel` have no outputs.

The `unitPrice` object is a `Source` for an `MdmMeasure` that represents values for the price of product units. The `MdmMeasure` has as inputs the `MdmPrimaryDimension` objects representing products and times, and the `unitPrice` `Source` has as inputs the `Source` objects for those dimensions.

The example selects elements of the dimension hierarchies and then joins the `Source` objects for the selections to that of the measure to produce `querySource`, which has `prodSel` and `timeSel` as outputs.

Example 9–1 *Creating the querySource Query*

```
Source timeSel = timeHier.selectValues(new String[]
    {"CALENDAR::MONTH::55",
     "CALENDAR::MONTH::58",
     "CALENDAR::MONTH::61",
     "CALENDAR::MONTH::64"});

Source prodSel = prodHier.selectValues(new String[]
    {"PRODUCT_ROLLUP::ITEM::13",
     "PRODUCT_ROLLUP::ITEM::14",
     "PRODUCT_ROLLUP::ITEM::15"});

Source querySource = unitPrice.join(timeSel).join(prodSel);
```

The result set defined by `querySource` is the unit price values for the selected products for the selected months. The results are organized by the outputs. Since `timeSel` is joined to the source produced by the `unitPrice.join(prodSel)` operation, `timeSel` is the slower varying output, which means that the result set specifies the set of selected products for each selected time value. For each time value the result set has three product values so the product values vary faster than the time values. The values of the base `ValueCursor` of `querySource` are the fastest varying of all, because there is one price value for each product for each day.

[Example 10–1](#) in [Chapter 10](#), creates a `Cursor`, `queryCursor`, for `querySource`. Since `querySource` has outputs, `queryCursor` is a `CompoundCursor`. The base `ValueCursor` of `queryCursor` has values from `unitPrice`, which is the base source of the operation that created `querySource`. The values from `unitPrice` are those specified by the outputs. The outputs for `queryCursor` are a `ValueCursor` that has values from `prodSel` and a `ValueCursor` that has values from `timeSel`.

[Figure 9–1](#) illustrates the structure of `queryCursor`. The base `ValueCursor` and the two output `ValueCursor` objects are the children of `queryCursor`, which is the parent `CompoundCursor`.

Figure 9–1 Structure of the `queryCursor` `CompoundCursor`

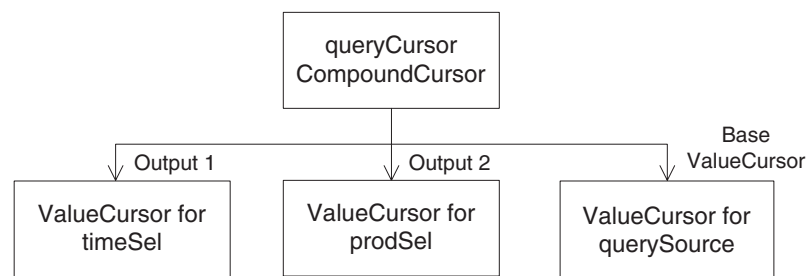

The following table displays the values from `queryCursor` in a table. The left column has time values, the middle column has product values, and the right column has the unit price of the product for the month.

Month	Product	Price of Unit
55	13	2426.07
55	14	3223.28
55	15	3042.22
58	13	2412.42
58	14	3107.65
58	15	3026.12
61	13	2505.57
61	14	3155.91
61	15	2892.18
64	13	2337.30
64	14	3105.53
64	15	2856.86

For examples of getting the values from a `ValueCursor`, see [Chapter 10](#).

Specifying the Behavior of a Cursor

CursorSpecification objects specify some aspects of the behavior of their corresponding Cursor objects. You must specify the behavior on a CursorSpecification before creating the corresponding Cursor. To specify the behavior, use the following CursorSpecification methods:

- `setDefaultFetchSize`
- `setExtentCalculationSpecified`
- `setParentEndCalculationSpecified`
- `setParentStartCalculationSpecified`
- `specifyDefaultFetchSizeOnChildren`
(for a CompoundCursorSpecification only)

A CursorSpecification also has methods that you can use to discover if the behavior is specified. Those methods are the following:

- `isExtentCalculationSpecified`
- `isParentEndCalculationSpecified`
- `isParentStartCalculationSpecified`

If you have used the CursorSpecification methods to set the default fetch size, or to calculate the extent or the starting or ending positions of a value in its parent, then you can successfully use the following Cursor methods:

- `getExtent`
- `getFetchSize`
- `getParentEnd`
- `getParentStart`
- `setFetchSize`

For examples of specifying Cursor behavior, see [Chapter 10](#). For information on fetch sizes, see ["About Fetch Sizes"](#) on page 9-18. For information on the extent of a Cursor, see ["What is the Extent of a Cursor?"](#) on page 9-17. For information on the starting and ending positions in a parent Cursor of the current value of a Cursor, see ["About the Parent Starting and Ending Positions in a Cursor"](#) on page 9-15.

CursorManagerSpecification Class

A CursorManagerSpecification for a Source has one or more CursorSpecification objects. The structure of those objects reflects the structure of the Source. For example, a Source that has outputs has a top-level, or *root*, CursorSpecification for the Source, a child CursorSpecification for the values of the Source, and a child CursorSpecification for each output of the Source.

A Source that does not have any outputs has only one set of values. A CursorManagerSpecification for that Source therefore has only one CursorSpecification. That CursorSpecification is the root CursorSpecification of the CursorManagerSpecification.

You can create a CursorManagerSpecification for a multidimensional Source that has one or more inputs. If you do so, then you need to supply a Source for each input when you create a CursorManager for the CursorManagerSpecification.

You must also supply a `CursorInput` for each input `Source` when you create a `Cursor` from the `CursorManager`. You might create a `CursorManagerSpecification` for a `Source` with inputs if you want to use a `CursorManager` to create a series of `Cursor` objects with each `Cursor` retrieving data specified by a different set of single values for the input `Source` objects.

The structure of a `Cursor` reflects the structure of its `CursorManagerSpecification`. A `Cursor` can be a single `ValueCursor`, for a `Source` with no outputs, or a `CompoundCursor` with child `Cursor` objects, for a `Source` with outputs. Each `Cursor` corresponds to a `CursorSpecification` in the `CursorManagerSpecification`. You use `CursorSpecification` methods to specify aspects of the behavior of the corresponding `Cursor`.

If your application uses `Template` objects, and a change occurs in the state of a `Template` so that the structure of the `Source` produced by the `Template` changes, then any `CursorManagerSpecification` objects that the application created for the `Source` expire. If a `CursorManagerSpecification` expires, then you must create a new `CursorManagerSpecification`. You can then either use the new `CursorManagerSpecification` to replace the old `CursorManagerSpecification` of a `CursorManager` or use it to create a new `CursorManager`. You can discover whether a `CursorManagerSpecification` has expired by calling the `isExpired` method of the `CursorManagerSpecification`.

CursorInfoSpecification Classes

The `CursorInfoSpecification` interface and its subinterfaces `CompoundCursorInfoSpecification` and `ValueCursorInfoSpecification`, specify methods for the abstract `CursorSpecification` class and the concrete `CompoundCursorSpecification` and `ValueCursorSpecification` classes. A `CursorSpecification` specifies certain aspects of the behavior of the `Cursor` that corresponds to it. You can create instances of classes that implement the `CursorInfoSpecification` interface either directly or indirectly.

You can create a `CursorInfoSpecification` for a `Source` directly by calling the `createCursorInfoSpecification` method of a `DataProvider`. You can use the methods of the `CursorInfoSpecification` to specify aspects of the behavior of a `Cursor`. You can then use the `CursorInfoSpecification` in creating a `CursorManager` by passing it as the `cursorInfoSpec` argument to the `createCursorManager` method of a `DataProvider`.

You can create a `CursorInfoSpecification` for a `Source` indirectly by creating a `CursorManagerSpecification`. You pass a `Source` to the `createCursorManagerSpecification` method of a `DataProvider` and the `CursorManagerSpecification` returned has a root `CursorSpecification` for that `Source`. If the `Source` has outputs, then the `CursorManagerSpecification` also has a child `CursorSpecification` for the values of the `Source` and one for each output of the `Source`.

With `CursorSpecification` methods, you can do the following:

- Get the `Source` that corresponds to the `CursorSpecification`.
- Get or set the default fetch size for the corresponding `Cursor`.
- On a `CompoundCursorSpecification`, specify that the default fetch size is set on the children of the corresponding `Cursor`.
- Specify that Oracle OLAP should calculate the extent of a `Cursor`.
- Determine whether calculating the extent is specified.

- Specify that Oracle OLAP should calculate the starting or ending position of the current value of the corresponding `Cursor` in its parent `Cursor`. If you know the starting and ending positions of a value in the parent, then you can determine how many faster varying elements the parent `Cursor` has for that value.
- Determine whether calculating the starting or ending position of the current value of the corresponding `Cursor` in its parent is specified.
- Accept a `CursorSpecificationVisitor`.

For more information, see ["About Cursor Positions and Extent"](#) on page 9-11 and ["About Fetch Sizes"](#) on page 9-18.

In the `oracle.olapi.data.source` package, the Oracle OLAP API defines the classes described in the following table.

Interface	Description
<code>CursorInfoSpecification</code>	An interface that specifies methods for <code>CursorSpecification</code> objects.
<code>CursorSpecification</code>	An abstract class that implements some methods of the <code>CursorInfoSpecification</code> interface.
<code>CompoundCursorSpecification</code>	A <code>CursorSpecification</code> for a <code>Source</code> that has one or more outputs. A <code>CompoundCursorSpecification</code> has component child <code>CursorSpecification</code> objects.
<code>CompoundInfoCursorSpecification</code>	An interface that specifies methods for <code>CompoundCursorSpecification</code> objects.
<code>ValueCursorSpecification</code>	A <code>CursorSpecification</code> for a <code>Source</code> that has values and no outputs.
<code>ValueCursorInfoSpecification</code>	An interface for <code>ValueCursorSpecification</code> objects.

A `Cursor` has the same structure as its `CursorManagerSpecification`. For every `ValueCursorSpecification` or `CompoundCursorSpecification` of a `CursorManagerSpecification`, a `Cursor` has a corresponding `ValueCursor` or `CompoundCursor`. To be able to get certain information or behavior from a `Cursor`, your application must specify that it wants that information or behavior by calling methods of the corresponding `CursorSpecification` before it creates the `Cursor`.

CursorManager Classes

The OLAP API has the following concrete classes for creating a `Cursor` for a `Source` or for getting the SQL generated by a `Source`.

- `ExpressDataCursorManager`
- `ExpressSpecifiedCursorManager`
- `ExpressSQLCursorManager`

An `ExpressSQLCursorManager` has methods that return the SQL generated by the Oracle OLAP SQL generator for the `Source`. You create one or more `ExpressSQLCursorManager` objects by calling the `createSQLCursorManager` or `createSQLCursorManagers` methods of a `DataProvider`. You do not use an `ExpressSQLCursorManager` to create a `Cursor` to retrieve the result set of the

query specified by the Source. Instead, you use the SQL returned by the `ExpressSQLCursorManager` with classes outside of the OLAP API to retrieve the data specified by the query.

An `ExpressDataCursorManager` or `ExpressSpecifiedCursorManager` returned by one of the `createCursorManager` methods of a `DataProvider` manages the buffering of data for the `Cursor` objects it creates.

You can create more than one `Cursor` from the same cursor manager, which is useful for displaying data from a result set in different formats such as a table or a graph. All of the `Cursor` objects created by a cursor manager have the same specifications, such as the default fetch sizes. Because the `Cursor` objects have the same specifications, they can share the data managed by the cursor manager.

An `ExpressSpecifiedCursorManager` implements the `SpecifiedCursorManager` interface, which extends the `CursorManager` interface. A `CursorManager` has methods for creating a `Cursor`, for discovering whether the `CursorManagerSpecification` for the `CursorManager` needs updating, and for adding or removing a `CursorManagerUpdateListener`. The `SpecifiedCursorManager` interface adds methods for updating the `CursorManagerSpecification`, for discovering whether the `SpecifiedCursorManager` is open, and for closing it. Some of the `createCursorManager` methods of `DataProvider` return an `ExpressSpecifiedCursorManager`, which is an implementation of the `SpecifiedCursorManager` interface.

When your application no longer needs a `SpecifiedCursorManager`, it should close it to free resources in the application and in Oracle OLAP. To close the `SpecifiedCursorManager`, call its `close` method.

Updating the `CursorManagerSpecification` for a `CursorManager`

If your application is using OLAP API `Template` objects and the state of a `Template` changes in a way that alters the structure of the `Source` produced by the `Template`, then any `CursorManagerSpecification` objects for the `Source` are no longer valid. You need to create new `CursorManagerSpecification` objects for the changed `Source`.

After creating a new `CursorManagerSpecification`, you can create a new `CursorManager` for the `Source`. You do not, however, need to create a new `CursorManager`. You can call the `updateSpecification` method of the existing `CursorManager` to replace the previous `CursorManagerSpecification` with the new `CursorManagerSpecification`. You can then create a new `Cursor` from the `CursorManager`.

To determine whether the `CursorManagerSpecification` for a `CursorManager` needs updating, call the `isSpecificationUpdateNeeded` method of the `CursorManager`. You can also use a `CursorManagerUpdateListener` to listen for events generated by changes in a `Source`. For more information, see "[CursorManagerUpdateListener Class](#)" on page 9-10.

Other Classes

This topic describes `CursorInput`, `CursorManagerUpdateListener`, and `CursorManagerUpdateEvent` classes in the `oracle.olapi.data.cursor` package.

CursorInput Class

For Oracle OLAP in Oracle Database 10g, the OLAP API includes `Parameter` classes, which are more convenient than `CursorInput` objects. With a `Parameter`, you can create a parameterized `Source`. You can create a `CursorManagerSpecification` for a query that includes a parameterized `Source`, and then create a `CursorManager` and a `Cursor`.

You can then change the value of the `Parameter`, which changes the selection of dimension or measure elements specified by the parameterized `Source`. The `Cursor` for the query then has the new set of values for the changed query. You do not need to prepare and commit the `Transaction` again before getting the values of the `Cursor`. For information on parameterized `Source` objects, see [Chapter 6, "Understanding Source Objects"](#).

A `CursorInput` provides a value for a `Source` that you include in the array of `Source` objects that is the `inputSources` argument to the `createCursorManager` method of a `DataProvider`. If you create a `CursorManagerSpecification` for a `Source` that has one or more inputs, then you must provide an `inputSources` argument when you create a `CursorManager` for that `CursorManagerSpecification`. You include a `Source` in the `inputSources` array for each input of the `Source` that you pass to the `createCursorManagerSpecification` method.

When you create a `CursorInput` object, you can specify either a single value or a `ValueCursor`. If you specify a `ValueCursor`, then you can call the `synchronize` method of the `CursorInput` to make the value of the `CursorInput` be the current value of the `ValueCursor`.

CursorManagerUpdateListener Class

`CursorManagerUpdateListener` is an interface that has methods that receive `CursorManagerUpdateEvent` object. Oracle OLAP generates a `CursorManagerUpdateEvent` object in response to a change that occurs in a `Source` that is produced by a `Template` or when a `CursorManager` updates its `CursorManagerSpecification`. Your application can use a `CursorManagerUpdateListener` to listen for events that indicate it might need to create new `Cursor` objects from the `CursorManager` or to update its display of data from a `Cursor`.

To use a `CursorManagerUpdateListener`, implement the interface, create an instance of the class, and then add the `CursorManagerUpdateListener` to the `CursorManager` for a `Source`. When a change to the `Source` occurs, the `CursorManager` calls the appropriate method of the `CursorManagerUpdateListener` and passes it a `CursorManagerUpdateEvent`. Your application can then perform the tasks needed to generate new `Cursor` objects and update the display of values from the result set that the `Source` defines.

You can implement more than one version of the `CursorManagerUpdateListener` interface. You can add instances of them to the same `CursorManager`.

CursorManagerUpdateEvent Class

Oracle OLAP generates a `CursorManagerUpdateEvent` object in response to a change that occurs in a `Source` that is produced by a `Template` or when a `CursorManager` updates its `CursorManagerSpecification`.

You do not directly create instances of this class. Oracle OLAP generates `CursorManagerUpdateEvent` objects and passes them to the appropriate methods

of any `CursorManagerUpdateListener` objects you have added to a `CursorManager`. The `CursorManagerUpdateEvent` has a field that indicates the type of event that occurred. A `CursorManagerUpdateEvent` has methods you can use to get information about it.

About Cursor Positions and Extent

A `Cursor` has one or more positions. The current position of a `Cursor` is the position that is currently active in the `Cursor`. To move the current position of a `Cursor` call the `setPosition` or `next` methods of the `Cursor`.

Oracle OLAP does not validate the position that you set on the `Cursor` until you attempt an operation on the `Cursor`, such as calling the `getCurrentValue` method. If you set the current position to a negative value or to a value that is greater than the number of positions in the `Cursor` and then attempt a `Cursor` operation, then the `Cursor` throws a `PositionOutOfBoundsException`.

The extent of a `Cursor` is described in "What is the Extent of a Cursor?" on page 9-17.

Positions of a ValueCursor

The current position of a `ValueCursor` specifies a value, which you can retrieve. For example, `prodSel`, a derived `Source` described in "Structure of a Cursor" on page 9-4, is a selection of three products from a primary `Source` that specifies a dimension of products and their hierarchical groupings. The `ValueCursor` for `prodSel` has three elements. The following example gets the position of each element of the `ValueCursor`, and displays the value at that position. The context object has a method that displays text.

```
// prodSelValCursor is the ValueCursor for prodSel
context.println("ValueCursor Position Value ");
context.println("----- ");
do
{
    context.println("          " + prodSelValCursor.getPosition() +
                   "          " + prodSelValCursor.getCurrentValue());
} while(prodSelValCursor.next());
```

The preceding example displays the following:

```
ValueCursor Position Value
-----
          1          PRODUCT_ROLLUP::ITEM::13
          2          PRODUCT_ROLLUP::ITEM::14
          3          PRODUCT_ROLLUP::ITEM::15
```

The following example sets the current position of `prodSelValCursor` to 2 and retrieves the value at that position.

```
prodSelValCursor.setPosition(2);
context.println(prodSelValCursor.getCurrentString());
```

The preceding example displays the following:

```
PRODUCT_ROLLUP::ITEM::14
```

For more examples of getting the current value of a `ValueCursor`, see [Chapter 10](#).

Positions of a CompoundCursor

A CompoundCursor has one position for each set of the elements of its descendent ValueCursor objects. The current position of the CompoundCursor specifies one of those sets.

For example, querySource, the Source created in Example 9-1, has values from a measure, unitPrice. The values are the prices of product units at different times. The outputs of querySource are Source objects that represent selections of four month values from a time dimension and three product values from a product dimension.

The result set for querySource has one measure value for each tuple (each set of output values), so the total number of values is twelve (one value for each of the three products for each of the four months). Therefore, the queryCursor CompoundCursor created for querySource has twelve positions.

Each position of queryCursor specifies one set of positions of its outputs and its base ValueCursor. For example, position 1 of queryCursor defines the following set of positions for its outputs and its base ValueCursor:

- Position 1 of output 1 (the ValueCursor for timeSel)
- Position 1 of output 2 (the ValueCursor for prodSel)
- Position 1 of the base ValueCursor for queryCursor (This position has the value from the unitPrice measure that is specified by the values of the outputs.)

Figure 9-2 illustrates the positions of queryCursor CompoundCursor, its base ValueCursor, and its outputs.

Figure 9-2 Cursor Positions in queryCursor

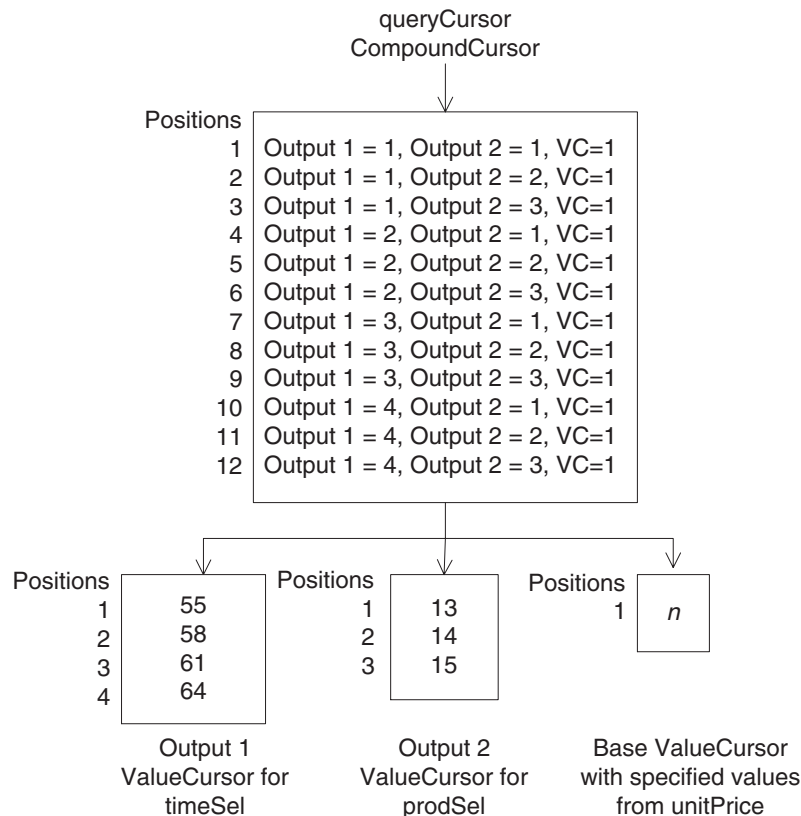

The ValueCursor for queryCursor has only one position because only one value of unitPrice is specified by any one set of values of the outputs. For a query like querySource, the ValueCursor of its Cursor has only one value, and therefore only one position, at a time for any one position of the root CompoundCursor.

Figure 9–3 illustrates one possible display of the data from queryCursor. It is a crosstab view with four columns and five rows. In the left column are the month values. In the top row are the product values. In each of the intersecting cells of the crosstab is the price of the product for the month.

Figure 9–3 Crosstab Display of queryCursor

Month	Product		
	13	14	15
55	2426.07	3223.28	3042.22
58	2412.42	3107.65	3026.12
61	2505.57	3155.91	2892.18
64	2337.30	3105.53	2856.86

A CompoundCursor coordinates the positions of its ValueCursor objects relative to each other. The current position of the CompoundCursor specifies the current positions of its descendent ValueCursor objects. Example 9–2 sets the position of queryCursor and then gets the current values and the positions of the child Cursor objects.

Example 9–2 Setting the CompoundCursor Position and Getting the Current Values

```
CompoundCursor rootCursor = (CompoundCursor) queryCursor;
ValueCursor baseValueCursor = rootCursor.getValueCursor();
List outputs = rootCursor.getOutputs();
ValueCursor output1 = (ValueCursor) outputs.get(0);
ValueCursor output2 = (ValueCursor) outputs.get(1);
int pos = 5;
rootCursor.setPosition(pos);
System.out.println("CompoundCursor position set to " + pos + ".");
System.out.println("The current position of the CompoundCursor is = "
    + rootCursor.getPosition() + ".");
System.out.println("Output 1 position = " + output1.getPosition() +
    ", value = " + output1.getCurrentValue());
System.out.println("Output 2 position = " + output2.getPosition() +
    ", value = " + output2.getCurrentValue());
System.out.println("VC position = " + baseValueCursor.getPosition() +
    ", value = " + baseValueCursor.getCurrentValue());
```

Example 9–2 displays the following:

```
CompoundCursor position set to 5.
The current position of the CompoundCursor is 5.
Output 1 position = 2, value = CALENDAR::MONTH::58
Output 2 position = 2, value = PRODUCT_ROLLUP::ITEM::14
VC position = 1, value = 3107.65
```

The positions of queryCursor are symmetric in that the result set for querySource always has three product values for each time value. The ValueCursor for prodSel,

therefore, always has three positions for each value of the `timeSel` `ValueCursor`. The `timeSel` output `ValueCursor` is slower varying than the `prodSel` `ValueCursor`.

In an asymmetric case, however, the number of positions in a `ValueCursor` is not always the same relative to its slower varying output. For example, if the price of units for product 15 for month 64 were null because that product was no longer being sold by that date, and if null values were suppressed in the query, then `queryCursor` would only have eleven positions. The `ValueCursor` for `prodSel` would only have two positions when the position of the `ValueCursor` for `timeSel` was 4.

Example 9-3 demonstrates an asymmetric result set that is produced by selecting elements of one dimension based on a comparison of measure values. The example uses the same product and time selections as in **Example 9-1**. It uses a `Source` for a measure of product units sold, `units`, that is dimensioned by product, time, sales channels, and customer dimensions. The `chanSel` and `custSel` objects are selections of single values of the dimensions. The example produces a `Source`, `querySource2`, that specifies which of the selected products sold more than one unit for the selected time, channel, and customer values.

Because `querySource2` is a derived `Source`, this example prepares and commits the current `Transaction`. The `TransactionProvider` in the example is `tp`. For information on `Transaction` objects, see **Chapter 8**.

The example creates a `Cursor` for `querySource2`, loops through the positions of the `CompoundCursor`, gets the position and current value of the first output `ValueCursor` and the `ValueCursor` of the `CompoundCursor`, and displays the positions and values of the `ValueCursor` objects. The `getLocalValue` method is a method in the program that extracts the local value from a unique value.

Example 9-3 *Positions in an Asymmetric Query*

```
// Create the query
querySource2 = prodSel.join(unitPrice).join(timeSel);

// Prepare and commit the current Transaction.
try
{
    tp.prepareCurrentTransaction();
}
catch(NotCommittableException e)
{
    output.println("Cannot commit current Transaction " + e);
}
tp.commitCurrentTransaction();

// Create the Cursor. The DataProvider is dp.
CursorManagerSpecification cursorMgrSpec =
    dp.createCursorManagerSpecification(querySource2);
CursorManager cursorManager = dp.createCursorManager(cursorMgrSpec);
Cursor queryCursor2 = cursorManager.createCursor();

CompoundCursor rootCursor = (CompoundCursor) queryCursor2;
ValueCursor baseValueCursor = rootCursor.getValueCursor();
List outputs = rootCursor.getOutputs();
ValueCursor output1 = (ValueCursor) outputs.get(0);

// Get the positions and values and display them.
System.out.println("CompoundCursor Output ValueCursor" +
    "    ValueCursor");
```

```

System.out.println("  position      position | value  " +
                  "position | value");
do
{
System.out.println("      " + rootCursor.getPosition() +
                  "      " + output1.getPosition() +
                  "      " + getLocalValue(output1.getCurrentString()) +
                  "      " + baseValueCursor.getPosition() + "      "
                  + getLocalValue(baseValueCursor.getCurrentString()));
}
while(queryCursor2.next());

```

Example 9-3 displays the following:

CompoundCursor position	Output position	ValueCursor value	ValueCursor position	ValueCursor value
1	1	55	1	13
2	1	55	2	14
3	1	55	3	15
4	2	58	1	15
5	3	61	1	14
6	3	61	2	15
7	4	64	1	13
8	4	64	2	14

Because not every combination of product and time selections has unit sales greater than 1 for the specified channel and customer selections, the number of elements of the ValueCursor for the values derived from prodSel is not the same for each value of the output ValueCursor. For time value 55, all three products have sales greater than one, but for time value 58, only one of the products does. The other two time values, 61 and 64, have two products that meet the criteria. Therefore, the ValueCursor for the CompoundCursor has three positions for time 55, only one position for time 58, and two positions for times 61 and 64.

About the Parent Starting and Ending Positions in a Cursor

To effectively manage the display of the data that you get from a CompoundCursor, you sometimes need to know how many faster varying values exist for the current slower varying value. For example, suppose that you are displaying in a crosstab one row of values from an edge of a cube, then you might want to know how many columns to draw in the display for the row.

To determine how many faster varying values exist for the current value of a child Cursor, you find the starting and ending positions of that current value in the parent Cursor. Subtract the starting position from the ending position and then add 1, as in the following.

```
long span = (cursor.getParentEnd() - cursor.getParentStart()) + 1;
```

The result is the span of the current value of the child Cursor in its parent Cursor, which tells you how many values of the fastest varying child Cursor exist for the current value. Calculating the starting and ending positions is costly in time and computing resources, so you should only specify that you want those calculations performed when your application needs the information.

An Oracle OLAP API Cursor enables your application to have only the data that it is currently displaying actually present on the client computer. For information on specifying the amount of data for a Cursor, see ["About Fetch Sizes"](#) on page 9-18.

From the data on the client computer, however, you cannot determine at what position of its parent `Cursor` the current value of a child `Cursor` begins or ends. To get that information, you use the `getParentStart` and `getParentEnd` methods of a `Cursor`.

For example, suppose your application has a `Source` named `cube` that represents a cube that has an asymmetric edge. The `cube Source` defines products with unit sales greater than one purchased by a certain customers during three months of the year 2001. The products were sold through the direct sales channel.

You create a `Cursor` for that `Source` and call it `cubeCursor`. The `CompoundCursor cubeCursor` has the following child `Cursor` objects:

- output 1, a `ValueCursor` for the channel values
- output 2, a `ValueCursor` for the time values
- output 4, a `ValueCursor` for the customer values
- The base `ValueCursor`, which has values that are the products with unit sales greater than one.

Figure 9-4 illustrates the parent, `cubeCursor`, with the values of its child `Cursor` objects layered horizontally. The slowest varying output, with the channel value, is at the top and the fastest varying child, with the product values, is at the bottom. The only portion of the edge that you are currently displaying in the user interface is the block between positions 9 and 12 of `cubeCursor`, which is shown within the bold border. The positions, 1 through 15, of `cubeCursor` appear over the top row.

Figure 9-4 Values of the ValueCursor Children of cubeCursor

1	2	3	4	5	6	7	8	9	10	11	12	13	14	15
2														
43				44					45					
58			61	58			61	58		61	65			
13	14	15	13	13	14	15	13	14	13	15	13	14	13	14

The current value of the output `ValueCursor` for the time `Source` is 44. You cannot determine from the data within the block that the starting and ending positions of the current value, 44, in the parent, `cubeCursor`, are 5 and 9, respectively.

The `cubeCursor` from the previous figure is shown again in Figure 9-5, this time with the range of the positions of the parent, `cubeCursor`, for each of the values of the child `Cursor` objects. By subtracting the smaller value from the larger value and adding one, you can compute the span of each value. For example, the span of the time value 44 is $(9 - 5 + 1) = 5$.

Figure 9–5 The Range of Positions of the Child Cursor Objects of cubeCursor

1	2	3	4	5	6	7	8	9	10	11	12	13	14	15
1 - 15														
1 - 4				5 - 9					10 - 15					
1 - 3			4	5 - 7			8 - 9		10 - 11		12 - 13		14 - 15	
1	2	3	4	5	6	7	8	9	10	11	12	13	14	15

To specify that you want Oracle OLAP to calculate the starting and ending positions of a value of a child Cursor in its parent Cursor, call the `setParentStartCalculationSpecified` and `setParentEndCalculationSpecified` methods of the `CursorSpecification` corresponding to the Cursor. You can determine whether calculating the starting or ending positions is specified by calling the `isParentStartCalculationSpecified` or `isParentEndCalculationSpecified` methods of the `CursorSpecification`. For an example of specifying these calculations, see [Chapter 10](#).

What is the Extent of a Cursor?

The extent of a Cursor is the total number of elements it contains relative to any slower varying outputs. [Figure 9–6](#) illustrates the number of positions of each child Cursor of `cubeCursor` relative to the value of its slower varying output. The child Cursor objects are layered horizontally with the slowest varying output at the top.

The total number of elements in `cubeCursor` is fifteen so the extent of `cubeCursor` is therefore fifteen. That number is over the top row of the figure. The top row is the `ValueCursor` for the channel value. The extent of the `ValueCursor` for channel values is one because it has only one value.

The second row down is the `ValueCursor` for the time values. Its extent is 3, since there are 3 months values. The next row down is the `ValueCursor` for the customer values. The extent of its elements depends on the value of the slower varying output, which is time. The extent of the customers `ValueCursor` for the first month is two, for the second month it is two, and for the third month it is three.

The bottom row is the base `ValueCursor` for the `cubeCursor` `CompoundCursor`. Its values are products. The extent of the elements of the products `ValueCursor` depends on the values of the customers `ValueCursor` and the time `ValueCursor`. For example, since three products values are specified by the first set of month and customer values (products 13, 14, and 15 for customer 58 for time 43), the extent of the products `ValueCursor` for that set is 3. For the second set of values for customers and times (customer 61 for time 43), the extent of the products `ValueCursor` is 1, and so on.

Figure 9–6 The Number of Elements of the Child Cursor Objects of cubeCursor

15

1														
1				2				3						
1			2	1			2	1		2	3			
1	2	3	1	1	2	3	1	2	1	2	1	2	1	2

The extent is information that you can use, for example, to display the correct number of columns or correctly-sized scroll bars. The extent, however, can be expensive to calculate. For example, a *Source* that represents a cube might have four outputs. Each output might have hundreds of values. If all null values and zero values of the measure for the sets of outputs are eliminated from the result set, then to calculate the extent of the *CompoundCursor* for the *Source*, Oracle OLAP must traverse the entire result space before it creates the *CompoundCursor*. If you do not specify that you want the extent calculated, then Oracle OLAP only needs to traverse the sets of elements defined by the outputs of the cube as specified by the fetch size of the *Cursor* and as needed by your application.

To specify that you want Oracle OLAP to calculate the extent for a *Cursor*, call the `setExtentCalculationSpecified` method of the *CursorSpecification* corresponding to the *Cursor*. You can determine whether calculating the extent is specified by calling the `isExtentCalculationSpecified` method of the *CursorSpecification*. For an example of specifying the calculation of the extent of a *Cursor*, see [Chapter 10](#).

About Fetch Sizes

An OLAP API *Cursor* represents the entire result set for a *Source*. The *Cursor* is a virtual *Cursor*, however, because it retrieves only a portion of the result set at a time from Oracle OLAP. A *CursorManager* manages a virtual *Cursor* and retrieves results from Oracle OLAP as your application needs it. By managing the virtual *Cursor*, the *CursorManager* relieves your application of a substantial burden.

The amount of data that a *Cursor* retrieves in a single fetch operation is determined by the fetch size specified for the *Cursor*. You specify a fetch size to limit the amount of data your application needs to cache on the local computer and to maximize the efficiency of the fetch by customizing it to meet the needs of your method of displaying the data.

You can also regulate the number of elements that Oracle OLAP returns by using *Parameter* and parameterized *Source* objects in constructing your query. For more information on *Parameter* objects, see [Chapter 6, "Understanding Source Objects"](#). For examples of using parameterized *Source* objects, see [Chapter 7, "Making Queries Using Source Methods"](#).

When you create a *CursorManagerSpecification* for a *Source*, as the first step in creating a *Cursor*, Oracle OLAP specifies a default fetch size on the root *CursorSpecification* of the *CursorManagerSpecification*. You can change the default fetch size with the `setDefaultFetchSize` method of the root *CursorSpecification*. You can also change the fetch size with the `setFetchSize` method of the *CursorManager* that you create using the *CursorManagerSpecification*, or with the `setFetchSize` method of a *Cursor* that you create with the *CursorManager*.

You can create two or more `Cursor` objects from the same `CursorManager` and use both `Cursor` objects simultaneously. Rather than having separate data caches, the `Cursor` objects can share the data managed by the `CursorManager`.

An example is an application that displays the results of a query to the user as both a table and a graph. The application creates a `CursorManagerSpecification` for a `Source` and then creates a `CursorManager` for the `CursorManagerSpecification`. The application creates two separate `Cursor` objects from the same `CursorManager`, one for a table view and one for a graph view. The two views share the same query and display the same data, just in different formats. [Figure 9-7](#) illustrates the relationship between the `Source`, the `Cursor` objects, and the views.

Figure 9-7 A Source and Two Cursors for Different Views of Its Values

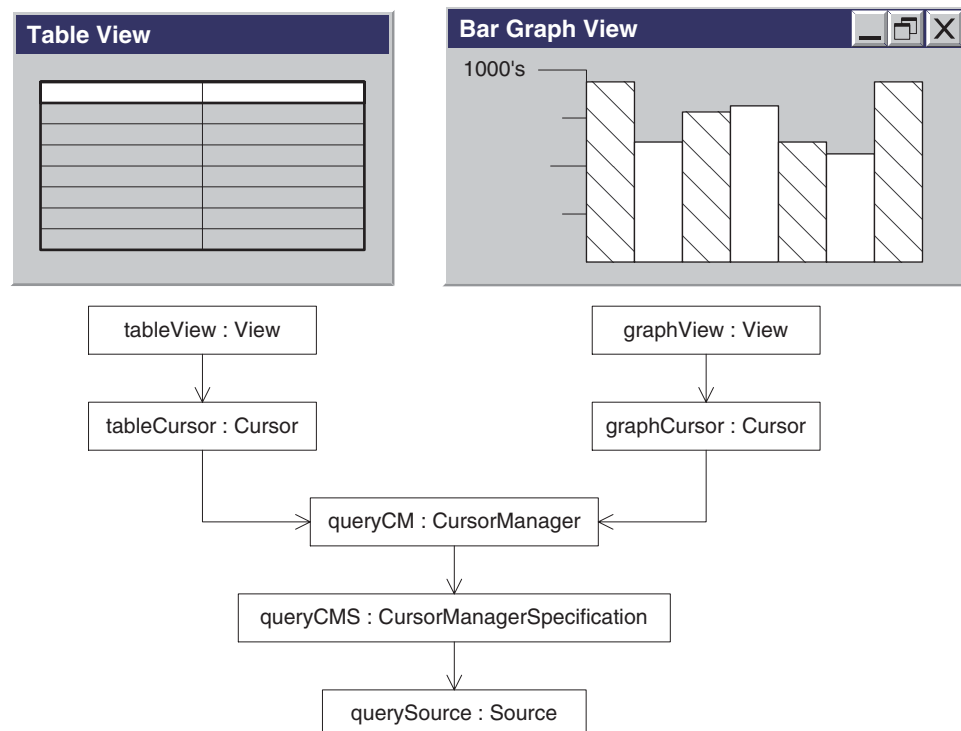

Retrieving Query Results

This chapter describes how to retrieve the results of a query with an Oracle OLAP API `Cursor` and how to gain access to those results. This chapter also describes how to customize the behavior of a `Cursor` to fit your method of displaying the results. For information on the class hierarchies of `Cursor` and its related classes, and for information on the `Cursor` concepts of position, fetch size, and extent, see [Chapter 9, "Understanding Cursor Classes and Concepts"](#).

This chapter includes the following topics:

- [Retrieving the Results of a Query](#)
- [Navigating a `CompoundCursor` for Different Displays of Data](#)
- [Specifying the Behavior of a `Cursor`](#)
- [Calculating Extent and Starting and Ending Positions of a Value](#)
- [Specifying a Fetch Size](#)

For the complete code of the examples in this chapter, see the example programs available from the Overview of the *Oracle OLAP Java API Reference*.

Retrieving the Results of a Query

A query is an OLAP API `Source` that specifies the data that you want to retrieve from Oracle OLAP and any calculations you want Oracle OLAP to perform on that data. A `Cursor` is the object that retrieves, or *fetches*, the result set specified by a `Source`. Creating a `Cursor` for a `Source` involves the following steps:

1. Get a primary `Source` from an `MdmObject` or create a derived `Source` through operations on a `DataProvider` or a `Source`. For information on getting or creating `Source` objects, see [Chapter 6, "Understanding Source Objects"](#).
2. If the `Source` is a derived `Source`, prepare and commit the `Transaction` in which you created the `Source`. To prepare and commit the `Transaction`, call the `prepareCurrentTransaction` and `commitCurrentTransaction` methods of your `TransactionProvider`. For more information on preparing and committing a `Transaction`, see [Chapter 8, "Using a TransactionProvider"](#). If the `Source` is a primary `Source`, then you do not need to prepare and commit the `Transaction`.
3. Create a `CursorManagerSpecification` by calling the `createCursorManagerSpecification` method of your `DataProvider` and passing that method the `Source`.
4. Create a `SpecifiedCursorManager` by calling the `createCursorManager` method of your `DataProvider` and passing that method the

CursorManagerSpecification. If the Source for the CursorManagerSpecification has one or more inputs, then you must also pass an array of Source objects that provides a Source for each input.

5. Create a Cursor by calling the createCursor method of the CursorManager. If you created the CursorManager with an array of input Source objects, then you must also pass an array of CursorInput objects that provides a value for each input Source.

Example 10–1 creates a Cursor for the derived Source named querySource. The example uses a TransactionProvider named tp and a DataProvider named dp. The example creates a CursorManagerSpecification named cursorMngrSpec, a SpecifiedCursorManager named cursorMngr, and a Cursor named queryCursor.

Finally, the example closes the SpecifiedCursorManager. When you have finished using the Cursor, you should close the SpecifiedCursorManager to free resources.

Example 10–1 Creating a Cursor

```
try
{
    tp.prepareCurrentTransaction();
}
catch(NotCommittableException e)
{
    System.out.println("Cannot commit the current Transaction. " + e);
}
tp.commitCurrentTransaction();
CursorManagerSpecification cursorMngrSpec =
    dp.createCursorManagerSpecification(querySource);
SpecifiedCursorManager cursorMngr =
    dp.createCursorManager(cursorMngrSpec);
Cursor queryCursor = cursorMngr.createCursor();

// ... Use the Cursor in some way, such as to display its values.

cursorMngr.close();
```

Getting Values from a Cursor

The Cursor interface encapsulates the notion of a *current position* and has methods for moving the current position. The ValueCursor and CompoundCursor interfaces extend the Cursor interface. The Oracle OLAP API has implementations of the ValueCursor and CompoundCursor interfaces. Calling the createCursor method of a CursorManager returns either a ValueCursor or a CompoundCursor implementation, depending on the Source for which you are creating the Cursor.

A ValueCursor is returned for a Source that has a single set of values. A ValueCursor has a value at its current position, and it has methods for getting the value at the current position.

A CompoundCursor is created for a Source that has more than one set of values, which is a Source that has one or more outputs. Each set of values of the Source is represented by a child ValueCursor of the CompoundCursor. A CompoundCursor has methods for getting its child Cursor objects.

The structure of the Source determines the structure of the Cursor. A Source can have nested outputs, which occurs when one or more of the outputs of the Source is

itself a `Source` with outputs. If a `Source` has a nested output, then the `CompoundCursor` for that `Source` has a child `CompoundCursor` for that nested output.

The `CompoundCursor` coordinates the positions of its child `Cursor` objects. The current position of the `CompoundCursor` specifies one set of positions of its child `Cursor` objects.

For an example of a `Source` that has only one level of output values, see [Example 10–4](#). For an example of a `Source` that has nested output values, see [Example 10–5](#).

An example of a `Source` that represents a single set of values is one returned by the `getSource` method of an `MdmDimension`, such as an `MdmPrimaryDimension` that represents product values. Creating a `Cursor` for that `Source` returns a `ValueCursor`. Calling the `getCurrentValue` method returns the product value at the current position of that `ValueCursor`.

[Example 10–2](#) gets the `Source` from `mdmProdHier`, which is an `MdmPrimaryDimension` that represents product values, and creates a `Cursor` for that `Source`. The example sets the current position to the fifth element of the `ValueCursor` and gets the product value from the `Cursor`. The example then closes the `CursorManager`. In the example, `dp` is the `DataProvider`.

Example 10–2 Getting a Single Value from a ValueCursor

```
Source prodSource = mdmProdHier.getSource();
// Because prodSource is a primary Source, you do not need to
// prepare and commit the current Transaction.
CursorManagerSpecification cursorMgrSpec =
    dp.createCursorManagerSpecification(productSource);
SpecifiedCursorManager cursorMgr =
    dp.createCursorManager(cursorMgrSpec);
Cursor prodCursor = cursorMgr.createCursor();
// Cast the Cursor to a ValueCursor.
ValueCursor prodValues = (ValueCursor) prodCursor;
// Set the position to the fifth element of the ValueCursor.
prodValues.setPosition(5);

// Product values are Strings. Get the String value at the current
// position.
String value = prodValues.getCurrentString();

// Do something with the value, such as display it...

// Close the SpecifiedCursorManager.
cursorMgr.close();
```

[Example 10–3](#) uses the same `Cursor` as [Example 10–2](#). [Example 10–3](#) uses a `do...while` loop and the `next` method of the `ValueCursor` to move through the positions of the `ValueCursor`. The `next` method begins at a valid position and returns `true` when an additional position exists in the `Cursor`. It also advances the current position to that next position.

The example sets the position to the first position of the `ValueCursor`. The example loops through the positions and uses the `getCurrentValue` method to get the value at the current position.

Example 10–3 Getting All of the Values from a ValueCursor

```
// prodValues is the ValueCursor for prodSource
prodValues.setPosition(1);
do
{
    System.out.println(prodValues.getCurrentValue);
} while(prodValues.next());
```

The values of the result set represented by a `CompoundCursor` are in the child `ValueCursor` objects of the `CompoundCursor`. To get those values, you must get the child `ValueCursor` objects from the `CompoundCursor`.

An example of a `CompoundCursor` is one that is returned by calling the `createCursor` method of a `CursorManager` for a `Source` that represents the values of a measure as specified by selected values from the dimensions of the measure.

[Example 10–4](#) uses a `Source`, named `units`, that results from calling the `getSource` method of an `MdmMeasure` that represents the number of units sold. The dimensions of the measure are `MdmPrimaryDimension` objects representing products, customers, times, and channels. This example uses `Source` objects that represent selected values from the default hierarchies of those dimensions. The names of those `Source` objects are `prodSel`, `custSel`, `timeSel`, and `chanSel`. The creation of the `Source` objects representing the measure and the dimension selections is not shown.

[Example 10–4](#) joins the dimension selections to the measure, which results in a `Source` named `unitsForSelections`. It creates a `CompoundCursor`, named `unitsForSelCursor`, for `unitsForSelections`, and gets the base `ValueCursor` and the outputs from the `CompoundCursor`. Each output is a `ValueCursor`, in this case. The outputs are returned in a `List`. The order of the outputs in the `List` is the inverse of the order in which the outputs were added to the list of outputs by the successive join operations. In the example, `dp` is the `DataProvider` and `tp` is the `TransactionProvider`.

Example 10–4 Getting ValueCursor Objects from a CompoundCursor

```
Source unitsForSelections = units.join(prodSel)
                                .join(custSel)
                                .join(timeSel)
                                .join(chanSel);

// Prepare and commit the current Transaction
try
{
    tp.prepareCurrentTransaction();
}
catch(NotCommittableException e)
{
    System.out.println("Cannot commit the current Transaction. " + e);
}
tp.commitCurrentTransaction();

// Create a Cursor for unitsForSelections
CursorManagerSpecification cursorMgrSpec =
    dp.createCursorManagerSpecification(unitsForSelections);
SpecifiedCursorManager cursorMgr =
    dp.createCursorManager(cursorMgrSpec);
CompoundCursor unitsForSelCursor = (CompoundCursor)
    cursorMgr.createCursor();
```

```

// Get the base ValueCursor
ValueCursor specifiedUnitsVals = unitsForSelCursor.getValueCursor();

// Get the outputs
List outputs = unitsForSelCursor.getOutputs();
ValueCursor chanSelVals = (ValueCursor) outputs.get(0);
ValueCursor timeSelVals = (ValueCursor) outputs.get(1);
ValueCursor custSelVals = (ValueCursor) outputs.get(2);
ValueCursor prodSelVals = (ValueCursor) outputs.get(3);

// You can now get the values from the ValueCursor objects.
// When you have finished using the Cursor objects, close the
// SpecifiedCursorManager.
cursorMngr.close();

```

Example 10-5 uses the same units measure as **Example 10-4**, but it joins the dimension selections to the measure differently. **Example 10-5** joins two of the dimension selections together. It then joins the result to the `Source` that results from joining the single dimension selections to the measure. The resulting `Source`, `unitsForSelections`, represents a query has nested outputs, which means it has more than one level of outputs.

The `CompoundCursor` that this example creates for `unitsForSelections` therefore also has nested outputs. The `CompoundCursor` has a child base `ValueCursor` and as its outputs has three child `ValueCursor` objects and one child `CompoundCursor`.

Example 10-5 joins the selection of channel dimension values, `chanSel`, to the selection of customer dimension values, `custSel`. The result is `custByChanSel`, a `Source` that has customer values as its base values and channel values as the values of its output. The example joins to `units` the selections of product and time values, and then joins `custByChanSel`. The resulting query is represented by `unitsForSelections`.

The example prepares and commits the current `Transaction` and creates a `CompoundCursor`, named `unitsForSelCursor`, for `unitsForSelections`.

The example gets the base `ValueCursor` and the outputs from the `CompoundCursor`. In the example, `dp` is the `DataProvider` and `tp` is the `TransactionProvider`.

Example 10-5 Getting Values from a CompoundCursor with Nested Outputs

```

// ...in someMethod...
Source custByChanSel = custSel.join(chanSel
Source unitsForSelections = units.join(prodSel)
                                .join(timeSel)
                                .join(custByChanSel);

// Prepare and commit the current Transaction
try
{
    tp.prepareCurrentTransaction();
}
catch(NotCommittableException e)
{
    System.out.println("Caught exception " + e + ".");
}
tp.commitCurrentTransaction();

```

```

// Create a Cursor for unitsForSelections
CursorManagerSpecification cursorMgrSpec =
    dp.createCursorManagerSpecification(unitsForSelections);
SpecifiedCursorManager cursorMgr =
    dp.createCursorManager(cursorMgrSpec);
Cursor unitsForSelCursor = cursorMgr.createCursor();

// Send the Cursor to a method that does different operations
// depending on whether the Cursor is a CompoundCursor or a
// ValueCursor.
printCursor(unitsForSelCursor);
cursorMgr.close();
// ...the remaining code of someMethod...

// The printCursor method has a do...while loop that moves through the positions
// of the Cursor passed to it. At each position, the method prints the number of
// the iteration through the loop and then a colon and a space. The output
// object is a PrintWriter. The method calls the private _printTuple method and
// then prints a new line. A "tuple" is the set of output ValueCursor values
// specified by one position of the parent CompoundCursor. The method prints one
// line for each position of the parent CompoundCursor.
private void printCursor(Cursor rootCursor)
{
    int i = 1;
    do
    {
        cpw.print(i++ + ": ");
        _printTuple(rootCursor);
        cpw.print("\n");
        cpw.flush();
    } while(rootCursor.next());
}

// If the Cursor passed to the _printTuple method is a ValueCursor,
// the method prints the value at the current position of the ValueCursor.
// If the Cursor passed in is a CompoundCursor, the method gets the
// outputs of the CompoundCursor and iterates through the outputs,
// recursively calling itself for each output. The method then gets the
// base ValueCursor of the CompoundCursor and calls itself again.
private void _printTuple(Cursor cursor)
{
    if(cursor instanceof CompoundCursor)
    {
        CompoundCursor compoundCursor = (CompoundCursor)cursor;
        // Put an open parenthesis before the value of each output
        cpw.print("(");
        Iterator iterOutputs = compoundCursor.getOutputs().iterator();
        Cursor output = (Cursor)iterOutputs.next();
        _printTuple(output);
        while(iterOutputs.hasNext())
        {
            // Put a comma after the value of each output
            cpw.print(",");
            _printTuple((Cursor)iterOutputs.next());
        }
        // Put a comma after the value of the last output
        cpw.print(",");
        // Get the base ValueCursor
        _printTuple(compoundCursor.getValueCursor());
    }
}

```

```

    // Put a close parenthesis after the base value to indicate
    // the end of the tuple.
    cpw.print(")");
}
else if(cursor instanceof ValueCursor)
{
    ValueCursor valueCursor = (ValueCursor) cursor;
    if (valueCursor.hasCurrentValue())
        print(valueCursor.getCurrentValue());
    else
        print("NA"); // If this position has a null value
}
}
}

```

Navigating a CompoundCursor for Different Displays of Data

With the methods of a `CompoundCursor` you can easily move through, or navigate, its structure and get the values from its `ValueCursor` descendents. Data from a multidimensional OLAP query is often displayed in a crosstab format, or as a table or a graph.

To display the data for multiple rows and columns, you loop through the positions at different levels of the `CompoundCursor` depending on the needs of your display. For some displays, such as a table, you loop through the positions of the parent `CompoundCursor`. For other displays, such as a crosstab, you loop through the positions of the child `Cursor` objects.

To display the results of a query in a table view, in which each row contains a value from each output `ValueCursor` and from the base `ValueCursor`, you determine the position of the top-level, or root, `CompoundCursor` and then iterate through its positions. [Example 10–6](#) displays only a portion of the result set at one time. It creates a `Cursor` for a `Source` that represents a query that is based on a measure that has unit cost values. The dimensions of the measure are the product and time dimensions. The creation of the primary `Source` objects and the derived selections of the dimensions is not shown.

The example joins the `Source` objects representing the dimension value selections to the `Source` representing the measure. It prepares and commits the current `Transaction` and then creates a `Cursor`, casting it to a `CompoundCursor`. The example sets the position of the `CompoundCursor`, iterates through twelve positions of the `CompoundCursor`, and prints out the values specified at those positions. The `TransactionProvider` is `tp` and the `DataProvider` is `dp`. The `cpw` object is a `PrintWriter`.

Example 10–6 Navigating for a Table View

```

Source unitPriceByMonth = unitPrice.join(productSel)
                                .join(timeSel);

try
{
    tp.prepareCurrentTransaction();
}
catch(NotCommittableException e)
{
    cpw.println("Cannot prepare the current Transaction. " + e);
}
tp.commitCurrentTransaction();

// Create a Cursor for unitPriceByMonth

```

```

CursorManagerSpecification cursorMngrSpec =
    dp.createCursorManagerSpecification(unitPriceByMonth);
SpecifiedCursorManager cursorMngr =
    dp.createCursorManager(cursorMngrSpec);
(CompoundCursor) rootCursor =
    (CompoundCursor) cursorMngr.createCursor();

// Determine a starting position and the number of rows to display
int start = 7;
int numRows =12;

cpw.println("Month      Product      Unit Price");
cpw.println("-----      -" );

// Iterate through the specified positions of the root CompoundCursor.
// Assume that the Cursor contains at least (start + numRows) positions.
for(int pos = start; pos < start + numRows; pos++)
{
    // Set the position of the root CompoundCursor
    rootCursor.setPosition(pos);
    // Print the local values of the output and base ValueCursors.
    // The getLocalValue method gets the local value from the unique
    // value of a dimension element.
    String timeValue = ((ValueCursor)rootCursor.getOutputs().get(0))
        .getCurrentString();
    String timeLocVal = getLocalValue(timeValue);
    String prodValue = ((ValueCursor)rootCursor.getOutputs().get(1))
        .getCurrentString();
    String prodLocVal = getLocalValue(prodValue);
    Object price = rootCursor.getValueCursor().getCurrentValue();
    cpw.println(" " + timeLocVal + "          " + prodLocVal
        + "          " + price);
};
cursorMngr.close();
    
```

If the time selection for the query has eight values, such as the first month of each calendar quarter for the years 2001 and 2002, and the product selection has three values, then the result set of the `unitPriceByMonth` query has twenty-four positions. [Example 10-6](#) displays the following table, which has the values specified by positions 7 through 18 of the `CompoundCursor`.

Month	Product	Unit Price
-----	-----	-----
61	13	2505.57
61	14	3155.91
61	15	2892.18
64	13	2337.30
64	14	3105.53
64	15	2856.86
69	13	4281.42
69	14	6017.90
69	15	5793.54
72	13	4261.76
72	14	5907.92
72	15	5760.78

[Example 10-7](#) uses the same query as [Example 10-6](#). In a crosstab view, the first row is column headings, which are the values from `prodSel` in this example. The output for `prodSel` is the faster varying output because the `prodSel` dimension selection is the last output in the list of outputs that results from the operations that join the measure

to the dimension selections. The remaining rows begin with a row heading. The row headings are values from the slower varying output, which is `timeSel`. The remaining positions of the rows, under the column headings, contain the `unitPrice` values specified by the set of the dimension values. To display the results of a query in a crosstab view, you iterate through the positions of the children of the top-level `CompoundCursor`.

The `TransactionProvider` is `tp` and the `DataProvider` is `dp`. The `cpw` object is a `PrintWriter`.

Example 10–7 Navigating for a Crosstab View without Pages

```
Source unitPriceByMonth = unitPrice.join(productSel)
                                   .join(timeSel);

try
{
    tp.prepareCurrentTransaction();
}
catch(NotCommittableException e)
{
    cpw.println("Cannot prepare the current Transaction. " + e);
}
tp.commitCurrentTransaction();

// Create a Cursor for unitPriceByMonth
CursorManagerSpecification cursorMngrSpec =
    dp.createCursorManagerSpecification(unitPriceByMonth);
SpecifiedCursorManager cursorMngr =
    dp.createCursorManager(cursorMngrSpec);
CompoundCursor rootCursor = (CompoundCursor)
    cursorMngr.createCursor();

// Get the outputs and the ValueCursor
List outputs = rootCursor.getOutputs();
// The first output has the values of timeSel, the slower varying output
ValueCursor rowCursor = (ValueCursor) outputs.get(0);
// The second output has the faster varying values of productSel
ValueCursor columnCursor = (ValueCursor) outputs.get(1);
// The base ValueCursor has the values from unitPrice
ValueCursor unitPriceValues = rootCursor.getValueCursor();

// Display the values as a crosstab.
cpw.println("\t        Product");
cpw.println("\t-----");
cpw.print("Month");
do
{
    String value = ((ValueCursor) columnCursor).getCurrentString();
    cpw.print("\t" + getLocalValue(value) + " ");
} while (columnCursor.next());
cpw.println();
cpw.println("-----\t-----\t-----\t-----");

// Reset the column Cursor to its first element.
columnCursor.setPosition(1);

do
{
    // Print the row dimension values.
    String value = ((ValueCursor) rowCursor).getCurrentString();
```

```

cpw.print(getLocalValue(value) + "\t");
// Loop over columns
do
{
    // Print data value
    cpw.print(unitPriceValues.getCurrentValue() + "\t");
} while (columnCursor.next());

cpw.println();

// Reset the column Cursor to its first element.
columnCursor.setPosition(1);
} while (rowCursor.next());

cursorMgr.close();
    
```

The following is a crosstab view of the values from the result set specified by the `unitPriceByMonth` query. The first line labels the rightmost three columns as having product values. The third line labels the first column as having month values and then labels each of the rightmost three columns with the product value for that column. The remaining lines have the month value in the left column and then have the data values from the units measure for the specified month and product.

	Product		
	-----	-----	-----
Month	13	14	15
-----	-----	-----	-----
55	2426.07	3223.28	3042.22
58	2412.42	3107.65	3026.12
61	2505.57	3155.91	2892.18
64	2337.30	3105.53	2856.86
69	4281.42	6017.90	5793.54
72	4261.76	5907.92	5760.78
75	4149.12	6004.68	5730.28
78	3843.24	5887.92	5701.76

[Example 10-8](#) creates a `Source` that is based on a measure of units sold values. The dimensions of the measure are the customer, product, time, and channel dimensions. The `Source` objects for the dimensions represent selections of the dimension values. The creation of those `Source` objects is not shown.

The query that results from joining the dimension selections to the measure `Source` represents unit sold values as specified by the values of its outputs.

The example creates a `Cursor` for the query and then sends the `Cursor` to the `printAsCrosstab` method, which prints the values from the `Cursor` in a crosstab. That method calls other methods that print page, column, and row values.

The fastest varying output of the `Cursor` is the selection of products, which has three values (the product items 13, 14, and 15). The product values are the column headings of the crosstab. The next fastest varying output is the selection of customers, which has three values (the customers 58, 61, and 65). Those three values are the row headings. The page dimensions are selections of three time values (the months 43, 44, and 45), and one channel value (2, which is the direct sales channel).

The `TransactionProvider` is `tp` and the `DataProvider` is `dp`. The `cpw` object is a `PrintWriter`. The `getLocalValue` method gets the local value from a unique dimension value.

Example 10–8 Navigating for a Crosstab View with Pages

```

// ...in someMethod...
Source unitsForSelections = units.join(prodSel)
                                .join(custSel)
                                .join(timeSel)
                                .join(chanSel);

try
{
    tp.prepareCurrentTransaction();
}
catch(NotCommittableException e)
{
    cpw.println("Cannot prepare the current Transaction. " + e);
}
tp.commitCurrentTransaction();

// Create a Cursor for unitsForSelections
CursorManagerSpecification cursorMngrSpec =
    dp.createCursorManagerSpecification(unitsForSelections);
SpecifiedCursorManager cursorMngr =
    dp.createCursorManager(cursorMngrSpec);
CompoundCursor unitsForSelCursor = (CompoundCursor)
    cursorMngr.createCursor();

// Send the Cursor to the printAsCrosstab method
printAsCrosstab(unitsForSelCursor);

cursorMngr.close();
// ...the remainder of the code of someMethod...

private void printAsCrosstab(CompoundCursor rootCursor)
{
    List outputs = rootCursor.getOutputs();
    int nOutputs = outputs.size();

    // Set the initial positions of all outputs
    Iterator outputIter = outputs.iterator();
    while (outputIter.hasNext())
        ((Cursor) outputIter.next()).setPosition(1);

    // The last output is fastest-varying; it represents columns.
    // The next to last output represents rows.
    // All other outputs are on the page.
    Cursor colCursor = (Cursor) outputs.get(nOutputs - 1);
    Cursor rowCursor = (Cursor) outputs.get(nOutputs - 2);
    ArrayList pageCursors = new ArrayList();
    for (int i = 0 ; i < nOutputs - 2 ; i++)
    {
        pageCursors.add(outputs.get(i));
    }

    // Get the base ValueCursor, which has the data values
    ValueCursor dataCursor = rootCursor.getValueCursor();

    // Print the pages of the crosstab
    printPages(pageCursors, 0, rowCursor, colCursor, dataCursor);
}

```

```

// Prints the pages of a crosstab
private void printPages(List pageCursors, int pageIndex, Cursor rowCursor,
    Cursor colCursor, ValueCursor dataCursor)
{
    // Get a Cursor for this page
    Cursor pageCursor = (Cursor) pageCursors.get(pageIndex);

    // Loop over the values of this page dimension
    do
    {
        // If this is the fastest-varying page dimension, print a page
        if (pageIndex == pageCursors.size() - 1)
        {
            // Print the values of the page dimensions
            printPageHeadings(pageCursors);

            // Print the column headings
            printColumnHeadings(colCursor);

            // Print the rows
            printRows(rowCursor, colCursor, dataCursor);

            // Print a couple of blank lines to delimit pages
            cpw.println();
            cpw.println();
        }

        // If this is not the fastest-varying page, recurse to the
        // next fastest varying dimension.
        else
        {
            printPages(pageCursors, pageIndex + 1, rowCursor, colCursor,
                dataCursor);
        }
    } while (pageCursor.next());

    // Reset this page dimension Cursor to its first element.
    pageCursor.setPosition(1);
}

// Prints the values of the page dimensions on each page
private void printPageHeadings(List pageCursors)
{
    // Print the values of the page dimensions
    Iterator pageIter = pageCursors.iterator();
    while (pageIter.hasNext())
    {
        String value = ((ValueCursor) pageIter.next()).getCurrentString();
        cpw.println(getLocalValue(value));
    }
    cpw.println();
}

// Prints the column headings on each page
private void printColumnHeadings(Cursor colCursor)
{
    do
    {
        cpw.print("\t");
        String value = ((ValueCursor) colCursor).getCurrentString();
    }
}

```

```

        cpw.print(getLocalValue(value));
    } while (colCursor.next());
    cpw.println();
    colCursor.setPosition(1);
}

// Prints the rows of each page
private void printRows(Cursor rowCursor, Cursor colCursor,
                      ValueCursor dataCursor)
{
    // Loop over rows
    do
    {
        // Print row dimension value
        String value = ((ValueCursor) rowCursor).getCurrentString();
        cpw.print(getLocalValue(value));
        cpw.print("\t");
        // Loop over columns
        do
        {
            // Print data value
            cpw.print(dataCursor.getCurrentValue());
            cpw.print("\t");
        } while (colCursor.next());
        cpw.println();

        // Reset the column Cursor to its first element
        colCursor.setPosition(1);
    } while (rowCursor.next());

    // Reset the row Cursor to its first element
    rowCursor.setPosition(1);
}

```

[Example 10-8](#) displays the following values, formatted as a crosstab. The display has added page, column, and row headings to identify the local values of the dimensions.

```

Channel  2
Customer 43

          Product
-----
Month   13    14    15
----- --   --   --
58      2     4     2
61      2     1     1
65      1     0     0

```

```

Channel  2
Customer 44

          Product
-----
Month   13    14    15
----- --   --   --
58      6     6     5
61      2     2     1
65      1     1     1

```

```

Channel 2
Customer 45

          Product
-----
Month  13   14   15
-----  --  --  --
58     2    0    2
61     3    2    0
65     2    2    0

```

Specifying the Behavior of a Cursor

You can specify the following aspects of the behavior of a `Cursor`.

- The **fetch size** of a `Cursor`, which is the number of elements of the result set that the `Cursor` retrieves during one fetch operation.
- Whether Oracle OLAP calculates the **extent** of the `Cursor`. The extent is the total number of positions of the `Cursor`. If the `Cursor` is a child `Cursor` of a `CompoundCursor`, its extent is relative to any slower varying outputs.
- Whether Oracle OLAP calculates the positions in the parent `Cursor` at which the value of a child `Cursor` starts or ends.

To specify the behavior of `Cursor`, you use methods of the `CursorSpecification` for that `Cursor`. To get the `CursorSpecification` for a `Cursor`, you use methods of the `CursorManagerSpecification` that you create for a `Source`.

Note: Specifying the calculation of the extent or the starting or ending position in a parent `Cursor` of the current value of a child `Cursor` can be a very expensive operation. The calculation can require considerable time and computing resources. You should only specify these calculations when your application needs them.

For more information on the relationships of `Source`, `Cursor`, `CursorSpecification`, and `CursorManagerSpecification` objects or the concepts of fetch size, extent, or `Cursor` positions, see [Chapter 9](#).

[Example 10-9](#) creates a `Source`, creates a `CursorManagerSpecification` for the `Source`, and then gets the `CursorSpecification` objects from a `CursorManagerSpecification`. The root `CursorSpecification` is the `CursorSpecification` for the top-level `CompoundCursor`.

Example 10-9 Getting `CursorSpecification` Objects from a `CursorManagerSpecification`

```

Source unitsForSelections = units.join(prodSel)
                               .join(custSel)
                               .join(timeSel)
                               .join(chanSel);

try
{
    tp.prepareCurrentTransaction();
}
catch (NotCommittableException e)
{
    System.out.println("Caught exception " + e + ".");
}

```

```

tp.commitCurrentTransaction();

// Create a Cursor for unitsForSelections
CursorManagerSpecification cursorMngrSpec =
    dp.createCursorManagerSpecification(unitsForSelections);

// Get the root CursorSpecification of the CursorManagerSpecification.
CompoundCursorSpecification rootCursorSpec =
    (CompoundCursorSpecification) cursorMngrSpec.getRootCursorSpecification();

// Get the CursorSpecification for the base values
ValueCursorSpecification baseValueSpec =
    rootCursorSpec.getValueCursorSpecification();

// Get the CursorSpecification objects for the outputs
List outputSpecs = rootCursorSpec.getOutputs();
ValueCursorSpecification promoSelValCSpec =
    (ValueCursorSpecification) outputSpecs.get(0);
ValueCursorSpecification chanSelValCSpec =
    (ValueCursorSpecification) outputSpecs.get(1);
ValueCursorSpecification timeSelValCSpec =
    (ValueCursorSpecification) outputSpecs.get(2);
ValueCursorSpecification prodSelValCSpec =
    (ValueCursorSpecification) outputSpecs.get(3);
ValueCursorSpecification custSelValCSpec =
    (ValueCursorSpecification) outputSpecs.get(4);

```

Once you have the `CursorSpecification` objects, you can use their methods to specify the behavior of the `Cursor` objects that correspond to them.

Calculating Extent and Starting and Ending Positions of a Value

To manage the display of the result set retrieved by a `CompoundCursor`, you sometimes need to know the extent of its child `Cursor` components. You might also want to know the position at which the current value of a child `Cursor` starts in its parent `CompoundCursor`. You might want to know the **span** of the current value of a child `Cursor`. The span is the number of positions of the parent `Cursor` that the current value of the child `Cursor` occupies. You can calculate the span by subtracting the starting position of the value from its ending position and subtracting 1.

Before you can get the extent of a `Cursor` or get the starting or ending positions of a value in its parent `Cursor`, you must specify that you want Oracle OLAP to calculate the extent or those positions. To specify the performance of those calculations, you use methods of the `CursorSpecification` for the `Cursor`.

[Example 10–10](#) specifies calculating the extent of a `Cursor`. The example uses the `CursorManagerSpecification` from [Example 10–9](#).

Example 10–10 Specifying the Calculation of the Extent of a Cursor

```

CompoundCursorSpecification rootCursorSpec = (CompoundCursorSpecification)
    cursorMngrSpec.getRootCursorSpecification();
rootCursorSpec.setExtentCalculationSpecified(true);

```

You can use methods of a `CursorSpecification` to determine whether the `CursorSpecification` specifies the calculation of the extent of a `Cursor` as in the following example.

```

boolean isSet = rootCursorSpec.isExtentCalculationSpecified();

```

[Example 10–11](#) specifies calculating the starting and ending positions of the current value of a child `Cursor` in its parent `Cursor`. The example uses the `CursorManagerSpecification` from [Example 10–9](#).

Example 10–11 Specifying the Calculation of Starting and Ending Positions in a Parent

```
CompoundCursorSpecification rootCursorSpec = (CompoundCursorSpecification)
    cursorMgrSpec.getRootCursorSpecification();

// Get the List of CursorSpecification objects for the outputs.
// Iterate through the list, specifying the calculation of the extent
// for each output CursorSpecification.
Iterator iterOutputSpecs = rootCursorSpec.getOutputs().iterator();
while(iterOutputSpecs.hasNext())
{
    ValueCursorSpecification valCursorSpec = (ValueCursorSpecification)
        iterOutputSpecs.next();
    valCursorSpec.setParentStartCalculationSpecified(true);
    valCursorSpec.setParentEndCalculationSpecified(true);
}
```

You can use methods of a `CursorSpecification` to determine whether the `CursorSpecification` specifies the calculation of the starting or ending positions of the current value of a child `Cursor` in its parent `Cursor`, as in the following example.

```
boolean isSet;
Iterator iterOutputSpecs = rootCursorSpec.getOutputs().iterator();
ValueCursorSpecification valCursorSpec = (ValueCursorSpecification)
    iterOutputSpecs.next();

while(iterOutputSpecs.hasNext())
{
    isSet = valCursorSpec.isParentStartCalculationSpecified();
    isSet = valCursorSpec.isParentEndCalculationSpecified();
    valCursorSpec = (ValueCursorSpecification) iterOutputSpecs.next();
}
```

[Example 10–12](#) determines the span of the positions in a parent `CompoundCursor` of the current value of a child `Cursor` for two of the outputs of the `CompoundCursor`. The example uses the `unitForSelections` Source from [Example 10–8](#).

The example gets the starting and ending positions of the current values of the time and product selections and then calculates the span of those values in the parent `Cursor`. The parent is the root `CompoundCursor`. The `TransactionProvider` is `tp`, the `DataProvider` is `dp`, and `cpw` is a `PrintWriter`.

Example 10–12 Calculating the Span of the Positions in the Parent of a Value

```
Source unitsForSelections = units.join(prodSel)
    .join(custSel)
    .join(timeSel)
    .join(chanSel);

try
{
    tp.prepareCurrentTransaction();
}
catch(NotCommittableException e)
{
    cpw.println("Caught exception " + e + ".");
}
```



```

tp.commitCurrentTransaction();

// Create a CursorManagerSpecification for unitsForSelections
CursorManagerSpecification cursorMngrSpec =
    dp.createCursorManagerSpecification(unitsForSelections);

// Get the root CursorSpecification from the CursorManagerSpecification.
CompoundCursorSpecification rootCursorSpec = (CompoundCursorSpecification)
    cursorMngrSpec.getRootCursorSpecification();
// Get the CursorSpecification objects for the outputs
List outputSpecs = rootCursorSpec.getOutputs();
ValueCursorSpecification timeSelValCSpec =
    (ValueCursorSpecification) outputSpecs.get(3); // output for time
ValueCursorSpecification prodSelValCSpec =
    (ValueCursorSpecification) outputSpecs.get(1); // output for product

// Specify the calculation of the starting and ending positions
timeSelValCSpec.setParentStartCalculationSpecified(true);
timeSelValCSpec.setParentEndCalculationSpecified(true);
prodSelValCSpec.setParentStartCalculationSpecified(true);
prodSelValCSpec.setParentEndCalculationSpecified(true);

// Create the CursorManager and the Cursor
SpecifiedCursorManager cursorMngr = dp.createCursorManager(cursorMngrSpec);
CompoundCursor rootCursor = (CompoundCursor) cursorMngr.createCursor();

// Get the child Cursor objects
ValueCursor baseValCursor = cursor.getValueCursor();
List outputs = rootCursor.getOutputs();
ValueCursor chanSelVals = (ValueCursor) outputs.get(0);
ValueCursor timeSelVals = (ValueCursor) outputs.get(1);
ValueCursor custSelVals = (ValueCursor) outputs.get(2);
ValueCursor prodSelVals = (ValueCursor) outputs.get(3);

// Set the position of the root CompoundCursor
rootCursor.setPosition(15);

// Get the values at the current position and determine the span
// of the values of the time and product outputs.
cpw.print(promoSelVals.getCurrentValue() + ", ");
cpw.print(chanSelVals.getCurrentValue() + ", ");
cpw.print(timeSelVals.getCurrentValue() + ", ");
cpw.print(custSelVals.getCurrentValue() + ", ");
cpw.print(prodSelVals.getCurrentValue() + ", ");
cpw.println(baseValCursor.getCurrentValue());

// Determine the span of the values of the two fastest varying outputs
int span;
span = (prodSelVals.getParentEnd() - prodSelVals.getParentStart()) +1;
cpw.println("The span of " + prodSelVals.getCurrentValue() +
    " at the current position is " + span + ".")
span = (timeSelVals.getParentEnd() - timeSelVals.getParentStart()) +1;
cpw.println("The span of " + timeSelVals.getCurrentValue() +
    " at the current position is " + span + ".")
cursorMngr.close();

```

This example displays the following text.

```
CHANNEL_ROLLUP::CHANNEL::2, CALENDAR::MONTH::44,  
SHIPMENTS_ROLLUP::SHIP_TO::61, PRODUCT_ROLLUP::ITEM::15, 1.0  
The span of PRODUCT_ROLLUP::ITEM::15 at the current position is 1.  
The span of CALENDAR::MONTH::44 at the current position is 9.
```

Specifying a Fetch Size

The number of elements of a `Cursor` that Oracle OLAP sends to the client application during one fetch operation depends on the fetch size specified for that `Cursor`. You can set the fetch size on the root `CursorSpecification` for a `Source`. `Cursor` for that `CursorSpecification` to change the fetch size of the `Cursor`. The default fetch size is 100.

[Example 10-13](#) uses the `CursorManagerSpecification` from [Example 10-9](#). It gets the default fetch size from the root `CursorSpecification`, creates a `Cursor` and sets a different fetch size on it, and then gets the fetch size for the `Cursor`. The `TransactionProvider` is `tp`, the `DataProvider` is `dp`, and `cpw` is a `PrintWriter`.

Example 10-13 Specifying a Fetch Size

```
CursorSpecification rootCursorSpec =  
    cursorMgrSpec.getRootCursorSpecification();  
context.println("The default fetch size is "  
    + rootCursorSpec.getDefaultFetchSize() + ".");  
CursorManager cursorMgr = dp.createCursorManager(cursorMgrSpec);  
Cursor rootCursor = cursorMgr.createCursor();  
rootCursor.setFetchSize(10);  
context.println("The fetch size is now " + rootCursor.getFetchSize())  
    + ".");
```

This example displays the following text.

```
The default fetch size is 100.  
The fetch size is now 10.
```

Creating Dynamic Queries

This chapter describes the Oracle OLAP API `Template` class and its related classes, which you use to create dynamic queries. This chapter also provides examples of implementations of those classes.

This chapter includes the following topics:

- [About Template Objects](#)
- [Overview of Template and Related Classes](#)
- [Designing and Implementing a Template](#)

For the complete code of the examples in this chapter, see the example programs available from the Overview of the *Oracle OLAP Java API Reference*.

About Template Objects

The `Template` class is the basis of a very powerful feature of the Oracle OLAP API. You use `Template` objects to create modifiable `Source` objects. With those `Source` objects, you can create dynamic queries that can change in response to end-user selections. `Template` objects also offer a convenient way for you to translate user-interface elements into OLAP API operations and objects.

These features are briefly described in the following section. The rest of this chapter describes the `Template` class and the other classes you use to create dynamic `Source` objects. For information on the `Transaction` objects that you use to make changes to the dynamic `Source` and to either save or discard those changes, see [Chapter 8](#), "Using a `TransactionProvider`".

About Creating a Dynamic Source

The main feature of a `Template` is its ability to produce a dynamic `Source`. That ability is based on two of the other objects that a `Template` uses: instances of the `DynamicDefinition` and `MetadataState` classes.

When a `Source` is created, a `SourceDefinition` is automatically created. The `SourceDefinition` has information about how the `Source` was created. Once created, the `Source` and its `SourceDefinition` are paired immutably. The `getSource` method of a `SourceDefinition` returns its paired `Source`.

`DynamicDefinition` is a subclass of `SourceDefinition`. A `Template` creates a `DynamicDefinition`, which acts as a proxy for the `SourceDefinition` of the `Source` produced by the `Template`. This means that instead of always getting the same immutably paired `Source`, the `getSource` method of the `DynamicDefinition` gets whatever `Source` is currently produced by the

Template. The instance of the `DynamicDefinition` does not change even though the `Source` that it gets is different.

The `Source` that a `Template` produces can change because the values, including other `Source` objects, that the `Template` uses to create the `Source` can change. A `Template` stores those values in a `MetadataState`. A `Template` provides methods to get the current state of the `MetadataState`, to get or set a value, and to set the state. You use those methods to change the data values the `MetadataState` stores.

You use a `DynamicDefinition` to get the `Source` produced by a `Template`. If your application changes the state of the values that the `Template` uses to create the `Source`, for example, in response to end-user selections, then the application uses the same `DynamicDefinition` to get the `Source` again, even though the new `Source` defines a result set different than the previous `Source`.

The `Source` produced by a `Template` can be the result of a series of `Source` operations that create other `Source` objects, such as a series of selections, sorts, calculations, and joins. You put the code for those operations in the `generateSource` method of a `SourceGenerator` for the `Template`. That method returns the `Source` produced by the `Template`. The operations use the data stored in the `MetadataState`.

You might build an extremely complex query that involves the interactions of dynamic `Source` objects produced by many different `Template` objects. The end result of the query building is a `Source` that defines the entire complex query. If you change the state of any one of the `Template` objects that you used to create the final `Source`, then the final `Source` represents a result set different than that of the previous `Source`. You can thereby modify the final query without having to reproduce all of the operations involved in defining the query.

About Translating User Interface Elements into OLAP API Objects

You design `Template` objects to represent elements of the user interface of an application. Your `Template` objects turn the selections that the end user makes into OLAP API query-building operations that produce a `Source`. You then create a `Cursor` to fetch the result set defined by the `Source` from Oracle OLAP. You get the values from the `Cursor` and display them to the end user. When an end user makes changes to the selections, you change the state of the `Template`. You then get the `Source` produced by the `Template`, create a new `Cursor`, get the new values, and display them.

Overview of Template and Related Classes

In the OLAP API, several classes work together to produce a dynamic `Source`. In designing a `Template`, you must implement or extend the following:

- The `Template` abstract class
- The `MetadataState` interface
- The `SourceGenerator` interface

Instances of those three classes, plus instances of other classes that Oracle OLAP creates, work together to produce the `Source` that the `Template` defines. The classes that Oracle OLAP provides, which you create by calling factory methods, are the following:

- `DataProvider`
- `DynamicDefinition`

What Is the Relationship Between the Classes That Produce a Dynamic Source?

The classes that produce a dynamic `Source` work together as follows:

- A `Template` has methods that create a `DynamicDefinition` and that get and set the current state of a `MetadataState`. An extension to the `Template` abstract class adds methods that get and set the values of fields on the `MetadataState`.
- The `MetadataState` implementation has fields for storing the data to use in generating the `Source` for the `Template`. When you create a new `Template`, you pass the `MetadataState` to the constructor of the `Template`. When you call the `getSource` method of the `DynamicDefinition`, the `MetadataState` is passed to the `generateSource` method of the `SourceGenerator`.
- The `DataProvider` is used in creating a `Template` and by the `SourceGenerator` in creating new `Source` objects.
- The `SourceGenerator` implementation has a `generateSource` method that uses the current state of the data in the `MetadataState` to produce a `Source` for the `Template`. You pass in the `SourceGenerator` to the `createDynamicDefinition` method of the `Template` to create a `DynamicDefinition`.
- The `DynamicDefinition` has a `getSource` method that gets the `Source` produced by the `SourceGenerator`. The `DynamicDefinition` serves as a proxy for the immutably paired `SourceDefinition` of that `Source`.

Template Class

You use a `Template` to produce a modifiable `Source`. A `Template` has methods for creating a `DynamicDefinition` and for getting and setting the current state of the `Template`. In extending the `Template` class, you add methods that provide access to the fields on the `MetadataState` for the `Template`. The `Template` creates a `DynamicDefinition` that you use to get the `Source` produced by the `SourceGenerator` for the `Template`.

For an example of a `Template` implementation, see [Example 11-1](#) on page 11-5.

MetadataState Interface

An implementation of the `MetadataState` interface stores the current state of the values for a `Template`. A `MetadataState` must include a `clone` method that creates a copy of the current state.

When instantiating a new `Template`, you pass a `MetadataState` to the `Template` constructor. The `Template` has methods for getting and setting the values stored by the `MetadataState`. The `generateSource` method of the `SourceGenerator` for the `Template` uses the `MetadataState` when the method produces a `Source` for the `Template`.

For an example of a `MetadataState` implementation, see [Example 11-2](#) on page 11-8.

SourceGenerator Interface

An implementation of `SourceGenerator` must include a `generateSource` method, which produces a `Source` for a `Template`. A `SourceGenerator` must produce only one type of `Source`, such as a `BooleanSource`, a `NumberSource`, or a `StringSource`. In producing the `Source`, the `generateSource` method uses the current state of the data represented by the `MetadataState` for the `Template`.

To get the Source produced by the `generateSource` method, you create a `DynamicDefinition` by passing the `SourceGenerator` to the `createDynamicDefinition` method of the `Template`. You then get the Source by calling the `getSource` method of the `DynamicDefinition`.

A `Template` can create more than one `DynamicDefinition`, each with a differently implemented `SourceGenerator`. The `generateSource` methods of the different `SourceGenerator` objects use the same data, as defined by the current state of the `MetadataState` for the `Template`, to produce Source objects that define different queries.

For an example of a `SourceGenerator` implementation, see [Example 11-3](#) on page 11-8.

DynamicDefinition Class

`DynamicDefinition` is a subclass of `SourceDefinition`. You create a `DynamicDefinition` by calling the `createDynamicDefinition` method of a `Template` and passing it a `SourceGenerator`. You get the Source produced by the `SourceGenerator` by calling the `getSource` method of the `DynamicDefinition`.

A `DynamicDefinition` created by a `Template` is a proxy for the `SourceDefinition` of the Source produced by the `SourceGenerator`. The `SourceDefinition` is immutably paired to its Source. If the state of the `Template` changes, then the Source produced by the `SourceGenerator` is different. Because the `DynamicDefinition` is a proxy, you use the same `DynamicDefinition` to get the new Source even though that Source has a different `SourceDefinition`.

The `getCurrent` method of a `DynamicDefinition` returns the `SourceDefinition` immutably paired to the Source that the `generateSource` method currently returns. For an example of the use of a `DynamicDefinition`, see [Example 11-4](#) on page 11-10.

Designing and Implementing a Template

The design of a `Template` reflects the query-building elements of the user interface of an application. For example, suppose you want to develop an application that allows the end user to create a query that requests a number of values from the top or bottom of a list of values. The values are from one dimension of a measure. The other dimensions of the measure are limited to single values.

The user interface of your application has a dialog box that allows the end user to do the following:

- Select a radio button that specifies whether the data values should be from the top or bottom of the range of values.
- Select a measure from a drop-down list of measures.
- Select a number from a field. The number specifies the number of data values to display.
- Select one of the dimensions of the measure as the base of the data values to display. For example, if the user selects the product dimension, then the query specifies some number of products from the top or bottom of the list of products. The list is determined by the measure and the selected values of the other dimensions.
- Click a button to bring up a Single Selections dialog box through which the end user selects the single values for the other dimensions of the selected measure.

After selecting the values of the dimensions, the end user clicks an OK button on the second dialog box and returns to the first dialog box.

- Click an OK button to generate the query. The results of the query appear.

To generate a *Source* that represents the query that the end user creates in the first dialog box, you design a *Template* called *TopBottomTemplate*. You also design a second *Template*, called *SingleSelectionTemplate*, to create a *Source* that represents the end user's selections of single values for the dimensions other than the base dimension. The designs of your *Template* objects reflect the user interface elements of the dialog boxes.

In designing the *TopBottomTemplate* and its *MetadataState* and *SourceGenerator*, you do the following:

- Create a class called *TopBottomTemplate* that extends *Template*. To the class, you add methods that get the current state of the *Template*, set the values specified by the user, and then set the current state of the *Template*.
- Create a class called *TopBottomTemplateState* that implements *MetadataState*. You provide fields on the class to store values for the *SourceGenerator* to use in generating the *Source* produced by the *Template*. The values are set by methods of the *TopBottomTemplate*.
- Create a class called *TopBottomTemplateGenerator* that implements *SourceGenerator*. In the *generateSource* method of the class, you provide the operations that create the *Source* specified by the end user's selections.

Using your application, an end user selects units sold as the measure and products as the base dimension in the first dialog box. From the Single Selections dialog box, the end user selects the Asia Pacific region, the first quarter of 2001, and the direct sales channel as the single values for each of the remaining dimensions.

The query that the end user has created requests the ten products that have the highest total amount of units sold through the direct sales channel to customers in the Asia Pacific region during the calendar year 2001.

For examples of implementations of the *TopBottomTemplate*, *TopBottomTemplateState*, and *TopBottomTemplateGenerator* classes, and an example of an application that uses them, see [Example 11-1](#), [Example 11-2](#), [Example 11-3](#), and [Example 11-4](#). The *TopBottomTemplateState* and *TopBottomTemplateGenerator* classes are implemented as inner classes of the *TopBottomTemplate* outer class.

Implementing the Classes for a Template

[Example 11-1](#) is an implementation of the *TopBottomTemplate* class.

Example 11-1 *Implementing a Template*

```
package globalExamples;

import oracle.olapi.data.source.DataProvider;
import oracle.olapi.data.source.DynamicDefinition;
import oracle.olapi.data.source.Source;
import oracle.olapi.data.source.SourceGenerator;
import oracle.olapi.data.source.Template;
import oracle.olapi.transaction.metadataStateManager.MetadataState;
```

```
/**
 * Creates a TopBottomTemplateState, a TopBottomTemplateGenerator,
 * and a DynamicDefinition. Gets the current state of the
 * TopBottomTemplateState and the values it stores. Sets the data
 * values stored by the TopBottomTemplateState and sets the changed state as
 * the current state.
 */
public class TopBottomTemplate extends Template
{
    // Constants for specifying the selection of elements from the
    // beginning or the end of the result set.
    public static final int TOP_BOTTOM_TYPE_TOP = 0;
    public static final int TOP_BOTTOM_TYPE_BOTTOM = 1;

    // Variable to store the DynamicDefinition.
    private DynamicDefinition _definition;

    /**
     * Creates a TopBottomTemplate with a default type and number values
     * and the specified base dimension.
     */
    public TopBottomTemplate(Source base, DataProvider dataProvider)
    {
        super(new TopBottomTemplateState(base, TOP_BOTTOM_TYPE_TOP, 0),
              dataProvider);
        // Create the DynamicDefinition for this Template. Create the
        // TopBottomTemplateGenerator that the DynamicDefinition uses.
        _definition =
            createDynamicDefinition(new TopBottomTemplateGenerator(dataProvider));
    }

    /**
     * Gets the Source produced by the TopBottomTemplateGenerator
     * from the DynamicDefinition.
     */
    public final Source getSource()
    {
        return _definition.getSource();
    }

    /**
     * Gets the Source that is the base of the elements in the result set.
     * Returns null if the state has no base.
     */
    public Source getBase()
    {
        TopBottomTemplateState state = (TopBottomTemplateState) getCurrentState();
        return state.base;
    }

    /**
     * Sets a Source as the base.
     */
    public void setBase(Source base)
    {
        TopBottomTemplateState state = (TopBottomTemplateState) getCurrentState();
        state.base = base;
        setCurrentState(state);
    }
}
```



```
/**
 * Gets the Source that specifies the measure and the single
 * selections from the dimensions other than the base.
 */
public Source getCriterion()
{
    TopBottomTemplateState state = (TopBottomTemplateState) getCurrentState();
    return state.criterion;
}

/**
 * Specifies a Source that defines the measure and the single values
 * selected from the dimensions other than the base.
 * The SingleSelectionTemplate produces such a Source.
 */
public void setCriterion(Source criterion)
{
    TopBottomTemplateState state = (TopBottomTemplateState) getCurrentState();
    state.criterion = criterion;
    setCurrentState(state);
}

/**
 * Gets the type, which is either TOP_BOTTOM_TYPE_TOP or
 * TOP_BOTTOM_TYPE_BOTTOM.
 */
public int getTopBottomType()
{
    TopBottomTemplateState state = (TopBottomTemplateState) getCurrentState();
    return state.topBottomType;
}

/**
 * Sets the type.
 */
public void setTopBottomType(int topBottomType)
{
    if ((topBottomType < TOP_BOTTOM_TYPE_TOP) ||
        (topBottomType > TOP_BOTTOM_TYPE_BOTTOM))
        throw new IllegalArgumentException("InvalidTopBottomType");
    TopBottomTemplateState state = (TopBottomTemplateState) getCurrentState();
    state.topBottomType = topBottomType;
    setCurrentState(state);
}

/**
 * Gets the number of values selected.
 */
public float getN()
{
    TopBottomTemplateState state = (TopBottomTemplateState) getCurrentState();
    return state.N;
}

/**
 * Sets the number of values to select.
 */
public void setN(float N)
{
    TopBottomTemplateState state = (TopBottomTemplateState) getCurrentState();
```

```
        state.N = N;
        setCurrentState(state);
    }
}
```

[Example 11–2](#) is an implementation of the `TopBottomTemplateState` inner class.

Example 11–2 Implementing a MetadataState

```
/**
 * Stores data that can be changed by its TopBottomTemplate.
 * The data is used by a TopBottomTemplateGenerator in producing
 * a Source for the TopBottomTemplate.
 */
private static final class TopBottomTemplateState
    implements Cloneable, MetadataState
{
    public int topBottomType;
    public float N;
    public Source criterion;
    public Source base;

    /**
     * Creates a TopBottomTemplateState.
     */
    public TopBottomTemplateState(Source base, int topBottomType, float N)
    {
        this.base = base;
        this.topBottomType = topBottomType;
        this.N = N;
    }

    /**
     * Creates a copy of this TopBottomTemplateState.
     */
    public final Object clone()
    {
        try
        {
            return super.clone();
        }
        catch(CloneNotSupportedException e)
        {
            return null;
        }
    }
}
```

[Example 11–3](#) is an implementation of the `TopBottomTemplateGenerator` inner class.

Example 11–3 Implementing a SourceGenerator

```
/**
 * Produces a Source for a TopBottomTemplate based on the data
 * values of a TopBottomTemplateState.
 */
private final class TopBottomTemplateGenerator
    implements SourceGenerator
{

```

```

// Store the DataProvider.
private DataProvider _dataProvider;

/**
 * Creates a TopBottomTemplateGenerator.
 */
public TopBottomTemplateGenerator(DataProvider dataProvider)
{
    _dataProvider = dataProvider;
}

/**
 * Generates a Source for a TopBottomTemplate using the current
 * state of the data values stored by the TopBottomTemplateState.
 */
public Source generateSource(MetadataState state)
{
    TopBottomTemplateState castState = (TopBottomTemplateState) state;
    if (castState.criterion == null)
        throw new NullPointerException("CriterionParameterMissing");
    Source sortedBase = null;
    if (castState.topBottomType == TOP_BOTTOM_TYPE_TOP)
        sortedBase = castState.base.sortDescending(castState.criterion);
    else
        sortedBase = castState.base.sortAscending(castState.criterion);
    return sortedBase.interval(1, Math.round(castState.N));
}
}

```

Implementing an Application That Uses Templates

After you have stored the selections made by the end user in the `MetadataState` for the Template, use the `getSource` method of the `DynamicDefinition` to get the dynamic Source created by the Template. This section provides an example of an application that uses the `TopBottomTemplate` described in [Example 11-1](#). For brevity, the code does not contain much exception handling.

The `Context10g` class used in the example has methods that do the following:

- Connects to an Oracle Database instance as the specified user.
- Provides the OLAP Catalog metadata objects for the measure and the dimensions selected by the end user.
- Creates Cursor objects and displays their values.

[Example 11-4](#) does the following:

- Creates a `Context10g` object and from it gets the `DataProvider` and the `TransactionProvider`.
- From the `Context10g` object, gets the `MdmMeasure` and the `MdmPrimaryDimension` objects that it uses.
- Creates a `SingleSelectionTemplate` for selecting single values from some of the dimensions of the measure. For the code of the `SingleSelectionTemplate` class that this example uses, see [Appendix B](#).
- Creates a `TopBottomTemplate` and stores selections made by the end user.
- Gets the Source produced by the `TopBottomTemplate`.

- Uses the `Context10g` object to create a `Cursor` for that `Source` and to display its values.

To use [Example 8–2](#) from [Chapter 8](#), replace the lines in the `run` method from the following comment to the end of the method

```
// Replace from here on for the Using Child Transaction example.
```

You can also get the complete code for the examples from the *Oracle OLAP Java API Reference*.

Example 11–4 Getting the Source Produced by the Template

```
import oracle.olapi.data.source.DataProvider;
import oracle.olapi.data.source.Source;
import oracle.olapi.data.source.StringSource;
import oracle.olapi.transaction.Transaction;
import oracle.olapi.transaction.TransactionProvider;
import oracle.olapi.transaction.NotCommittableException;
import oracle.olapi.metadata.mdm.MdmDimensionMemberInfo;
import oracle.olapi.metadata.mdm.MdmHierarchy;
import oracle.olapi.metadata.mdm.MdmMeasure;
import oracle.olapi.metadata.mdm.MdmPrimaryDimension;

import java.util.Iterator;
import java.util.ArrayList;
import java.util.List;

/**
 * Creates a query that specifies a number of elements from the top
 * or bottom of a selection of dimension members, creates a Cursor
 * for the query, and displays the values of the Cursor.
 * The selected dimension members are those that have measure values
 * that are specified by selected members of the other dimensions of
 * the measure.
 */
public class TopBottomTest
{
    /**
     * Creates a Context10g object that connects to an Oracle Database instance.
     * Gets the MdmMeasure for the Global schema UNITS measure
     * and the MdmPrimaryDimension objects for that measure.
     * Gets the default hierarchies for the dimensions and then gets the Source
     * object for the base of the query.
     * Creates a SingleSelectionTemplate and adds selections to it.
     * Creates a TopBottomTemplate and sets its properties.
     * Gets the Source produced by the TopBottomTemplate, creates a Cursor
     * for it, and displays the values of the Cursor.
     * Changes the state of the SingleSelectionTemplate and the
     * TopBottomTemplate, creates a new Cursor for the Source produced by the
     * TopBottomTemplate, and displays the values of that Cursor.
     */
    public void run(String[] args)
    {
        // Create a Context10g object and get the DataProvider and
        // TransactionProvider from it.
        Context10g context = new Context10g(args, false);
        DataProvider dp = context.getDataProvider();
        TransactionProvider tp = context.getTransactionProvider();
```

```

// Get the MdmMeasure for the measure.
MdmMeasure mdmUnits = context.getMdmMeasureByName("UNITS");
// Get the Source for the measure.
Source units = mdmUnits.getSource();

// Get the MdmPrimaryDimension objects for the dimensions of the measure.
MdmPrimaryDimension[] mdmPrimDims =
    context.getMdmPrimaryDimensionsByName(new String[]
        {"CUSTOMER",
         "PRODUCT",
         "CHANNEL",
         "TIME"});

MdmPrimaryDimension mdmCustDim = mdmPrimDims[0];
MdmPrimaryDimension mdmProdDim = mdmPrimDims[1];
MdmPrimaryDimension mdmChanDim = mdmPrimDims[2];
MdmPrimaryDimension mdmTimeDim = mdmPrimDims[3];

// Get the default hierarchy of the Product dimension.
MdmHierarchy mdmProdRollup = mdmProdDim.getDefaultHierarchy();

// Get the StringSource for the hierarchy.
StringSource prodRollup = (StringSource) mdmProdRollup.getSource();

// Create a SingleSelectionTemplate to produce a Source that
// represents the measure values specified by single members of each of
// the dimensions of the measure other than the base dimension.
SingleSelectionTemplate singleSelections =
    new SingleSelectionTemplate(units, dp);

// Create MdmDimensionMemberInfo objects for single members of the
// other dimensions of the measure.
MdmDimensionMemberInfo timeMemInfo =
    new MdmDimensionMemberInfo(mdmTimeDim, "CALENDAR::YEAR::4");
MdmDimensionMemberInfo custMemInfo =
    new MdmDimensionMemberInfo(mdmCustDim, "SHIPMENTS_ROLLUP::REGION::8");
MdmDimensionMemberInfo chanMemInfo =
    new MdmDimensionMemberInfo(mdmChanDim, "CHANNEL_ROLLUP::CHANNEL::2");

// Add the dimension member information objects to the
// SingleSelectionTemplate.
singleSelections.addDimMemberInfo(custMemInfo);
singleSelections.addDimMemberInfo(chanMemInfo);
singleSelections.addDimMemberInfo(timeMemInfo);

// Create a TopBottomTemplate specifying, as the base, the Source for a
// a hierarchy of a dimension.
TopBottomTemplate topNBottom = new TopBottomTemplate(prodRollup, dp);

// Specify whether to retrieve the elements from the beginning (top) or the
// end (bottom) of the selected elements of the base dimension.
topNBottom.setTopBottomType(TopBottomTemplate.TOP_BOTTOM_TYPE_TOP);

// Set the number of elements of the base dimension to retrieve.
topNBottom.setN(10);
// Get the Source produced by the SingleSelectionTemplate and specify it as
// the criterion object.
topNBottom.setCriterion(singleSelections.getSource());

```

```
// Prepare and commit the current transaction.
try
{
    tp.prepareCurrentTransaction();
}
catch(NotCommittableException e)
{
    context.println("Cannot commit the current Transaction. " + e);
}
tp.commitCurrentTransaction();

// Replace from here on for the Using Child Transaction Objects example.

// Get the short value descriptions of the dimension members from the
// SingleSelectionTemplate.
StringBuffer shortDescrsForMemberVals =
    singleSelections.getMemberShortDescrs(dp, tp);
context.println("\nThe " + Math.round(topNBottom.getN()) +
    " products with the most units sold \nfor" +
    shortDescrsForMemberVals + " are:\n");

// Get the Source produced by the TopBottomTemplate, create a Cursor
// for it, and display the values of the Cursor.
Source result = topNBottom.getSource();
context.displayTopBottomResult(result);

// Change a dimension member selection of the SingleSelectionTemplate.
timeMemInfo.setUniqueValue("CALENDAR:YEAR:3");
singleSelections.changeSelection(timeMemInfo);

// After changing the selection of a dimension member, get the short value
// descriptions of the dimension members again.
StringBuffer shortDescrsForMemberValsAfter =
    singleSelections.getMemberShortDescrs(dp, tp);

// Change the number of elements selected and the type of selection.
topNBottom.setN(5);
topNBottom.setTopBottomType(TopBottomTemplate.TOP_BOTTOM_TYPE_BOTTOM);

// Prepare and commit the current transaction.
try
{
    tp.prepareCurrentTransaction();
}
catch(NotCommittableException e)
{
    context.println("Cannot commit the current Transaction. " + e);
}

tp.commitCurrentTransaction();

context.println("\nThe " + Math.round(topNBottom.getN()) + " products " +
    "with the fewest units sold \nfor" +
    shortDescrsForMemberValsAfter + " are:\n");

// Create a new Cursor for the Source produced by the TopBottomTemplate
// and display the Cursor values.
context.displayTopBottomResult(result);
}
```

```
/**
 * Runs the TopBottomTest application.
 *
 * @param args An array of String objects that provides the arguments
 *             required to connect to an Oracle Database instance, as
 *             specified in the Context10g class.
 */
public static void main(String[] args)
{
    new TopBottomTest().run(args);
}
}
```

The TopBottomTest program produces the following output.

The 10 products with the most units sold
for Asia Pacific, Direct Sales, 2001 are:

1. PRODUCT_ROLLUP::TOTAL_PRODUCT::1
2. PRODUCT_ROLLUP::CLASS::3
3. PRODUCT_ROLLUP::FAMILY::7
4. PRODUCT_ROLLUP::CLASS::2
5. PRODUCT_ROLLUP::FAMILY::9
6. PRODUCT_ROLLUP::FAMILY::6
7. PRODUCT_ROLLUP::FAMILY::11
8. PRODUCT_ROLLUP::ITEM::30
9. PRODUCT_ROLLUP::ITEM::28
10. PRODUCT_ROLLUP::ITEM::47

The 5 products with the fewest units sold
for Asia Pacific, Direct Sales, 2000 are:

1. PRODUCT_ROLLUP::ITEM::44
2. PRODUCT_ROLLUP::ITEM::36
3. PRODUCT_ROLLUP::ITEM::43
4. PRODUCT_ROLLUP::ITEM::38
5. PRODUCT_ROLLUP::ITEM::21

Setting Up the Development Environment

This appendix describes the development environment for creating applications that use the OLAP API.

This appendix includes the following topics:

- [Overview](#)
- [Required Class Libraries](#)
- [Obtaining the Class Libraries](#)

Overview

The Oracle Database installation, with the OLAP option, provides the OLAP API and other class libraries, as `jar` files, that you require to develop an OLAP API client application. As an application developer, you must copy the required `jar` files to the computer on which you develop your Java application, or otherwise make them accessible to your development environment.

Required Class Libraries

Your application development environment must have the following files:

- The OLAP API `jar` file, which contains the OLAP API class libraries.
- Certain Oracle JDBC (Java Database Connectivity) `jar` files, which provide communications between the application and the Oracle database. The Oracle installation includes the JDBC files. You must use these JDBC files and not those from another Oracle product or those from a product from another vendor.
- The Java Development Kit (JDK) version 1.4. The Oracle installation does not provide the JDK. For information about obtaining and using it, see the Sun Microsystems Java Web site at

<http://java.sun.com>

If you are using Oracle JDeveloper as your development environment, the JDK is already installed on your computer. However, ensure that you are using the correct version of the JDK in JDeveloper.

Obtaining the Class Libraries

[Table A-1](#) lists the OLAP API and other `jar` files that you must include in your application development environment. The table includes the locations of the files under the directory identified by the `ORACLE_HOME` environment variable on the

system on which the Oracle database is installed. You can copy these files to your application development computer, or otherwise include them in your development environment.

Table A-1 Required Class Libraries and Their Locations in the Oracle Installation

Class Library jar File	Location under ORACLE_HOME
<code>olap_api.jar</code>	<code>/olap/api/lib</code>
<code>classes12.jar</code>	<code>/jdbc/lib</code>
<code>xmlparserv2.jar</code>	<code>/lib</code>

The `olap_api.jar` file contain the OLAP API classes. The `classes12.jar` file contains JDBC classes, and the `xmlparserv2.jar` file contains classes that provide XML parsing support.

SingleSelectionTemplate Class

This appendix contains the code for the `SingleSelectionTemplate` class. This class is used by the examples in [Chapter 8, "Using a TransactionProvider"](#), and [Chapter 11, "Creating Dynamic Queries"](#).

This class is also available as the `SingleSelectionTemplate.java` file. To open the file, click the Example Oracle OLAP Java API Programs link in the Overview of the *Oracle OLAP Java API Reference* and then click the file name.

Code for the SingleSelectionTemplate Class

The following is the `SingleSelectionTemplate.java` class.

```
import oracle.olapi.data.cursor.CursorManager;
import oracle.olapi.data.cursor.ValueCursor;
import oracle.olapi.data.source.DataProvider;
import oracle.olapi.data.source.DynamicDefinition;
import oracle.olapi.data.source.Source;
import oracle.olapi.data.source.StringSource;
import oracle.olapi.data.source.SourceGenerator;
import oracle.olapi.data.source.Template;
import oracle.olapi.transaction.TransactionProvider;
import oracle.olapi.transaction.NotCommittableException;
import oracle.olapi.transaction.metadataStateManager.MetadataState;
import oracle.olapi.metadata.mdm.MdmAttribute;
import oracle.olapi.metadata.mdm.MdmDimensionMemberInfo;
import oracle.olapi.metadata.mdm.MdmHierarchy;
import oracle.olapi.metadata.mdm.MdmMeasure;
import oracle.olapi.metadata.mdm.MdmPrimaryDimension;

import java.util.ArrayList;
import java.util.Collections;
import java.util.Iterator;
import java.util.List;

/**
 * A Template that joins Source objects for selected members of
 * dimension hierarchies to a Source for a measure.
 */
public class SingleSelectionTemplate extends Template
{
    // Variable to store the DynamicDefinition.
    private DynamicDefinition _definition;
```

```
/**
 * Creates a SingleSelectionTemplate.
 */
public SingleSelectionTemplate(Source measure, DataProvider dataProvider)
{
    super(new SingleSelectionTemplateState(measure), dataProvider);
    _definition = createDynamicDefinition(
        new SingleSelectionTemplateGenerator(dataProvider));
}

/**
 * Gets the Source produced by the SingleSelectionTemplateGenerator
 * from the DynamicDefinition.
 */
public final Source getSource()
{
    return _definition.getSource();
}

/**
 * Gets the measure stored by the SingleSelectionTemplateState.
 */
public Source getMeasure()
{
    SingleSelectionTemplateState state =
        (SingleSelectionTemplateState) getCurrentState();
    return state.measure;
}

/**
 * Gets the List of MdmDimensionMemberInfo objects for the selected members
 * of the dimensions.
 */
public List getDimMemberInfos()
{
    SingleSelectionTemplateState state =
        (SingleSelectionTemplateState) getCurrentState();
    return Collections.unmodifiableList(state.dimMemberInfos);
}

/**
 * Adds an MdmDimensionMemberInfo to the List of
 * MdmDimensionMemberInfo objects.
 */
public void addDimMemberInfo(MdmDimensionMemberInfo mdmDimMemberInfo)
{
    SingleSelectionTemplateState state =
        (SingleSelectionTemplateState) getCurrentState();
    state.dimMemberInfos.add(mdmDimMemberInfo);
    setCurrentState(state);
}

/**
 * Changes the member specified for a dimension.
 */
public void changeSelection(MdmDimensionMemberInfo mdmDimMemberInfo)
{
    SingleSelectionTemplateState state =
        (SingleSelectionTemplateState) getCurrentState();
    int i = 0;
```

```

Iterator dimMemberInfosItr = state.dimMemberInfos.iterator();
while (dimMemberInfosItr.hasNext())
{
    MdmDimensionMemberInfo mdmDimMemberInfoInList =
        (MdmDimensionMemberInfo) dimMemberInfosItr.next();
    MdmPrimaryDimension mdmPrimDim1 = mdmDimMemberInfo.getPrimaryDimension();
    MdmPrimaryDimension mdmPrimDim2 =
        mdmDimMemberInfoInList.getPrimaryDimension();
    //String value = (String) valuesItr.next();
    if (mdmPrimDim1.getName().equals(mdmPrimDim2.getName()))
    {
        state.dimMemberInfos.remove(i);
        state.dimMemberInfos.add(i, mdmDimMemberInfo);
        break;
    }
    i++;
}

setCurrentState(state);
}

/**
 * Gets the short value description of the each of the dimension members
 * specified by the list of MdmDimensionMemberInfo objects and returns
 * the descriptions in a StringBuffer.
 */
StringBuffer getMemberShortDescrs(DataProvider dp,
                                TransactionProvider tp)
{
    boolean firsttime = true;

    List mdmDimMemInfoList = getDimMemberInfos();

    StringBuffer shortDescrForMemberVals = new StringBuffer(" ");
    Iterator mdmDimMemInfoListItr = mdmDimMemInfoList.iterator();

    while(mdmDimMemInfoListItr.hasNext())
    {
        MdmDimensionMemberInfo mdmDimMemInfo = (MdmDimensionMemberInfo)
            mdmDimMemInfoListItr.next();
        MdmPrimaryDimension mdmPrimDim = mdmDimMemInfo.getPrimaryDimension();
        MdmAttribute mdmShortDescrAttr =
            mdmPrimDim.getShortValueDescriptionAttribute();
        Source shortDescrAttr = mdmShortDescrAttr.getSource();
        MdmHierarchy mdmHier = mdmDimMemInfo.getHierarchy();
        StringSource hierSrc = (StringSource) mdmHier.getSource();
        Source memberSel = hierSrc.selectValue(mdmDimMemInfo.getUniqueValue());
        Source shortDescrForMember = shortDescrAttr.joinHidden(memberSel);

        // Prepare and commit the current transaction.
        try
        {
            tp.prepareCurrentTransaction();
        }
        catch (NotCommittableException e)
        {
            System.out.println("Cannot commit the current Transaction. " + e);
        }
        tp.commitCurrentTransaction();
    }
}

```

```
CursorManager cmngr = dp.createCursorManager(shortDescrForMember);
ValueCursor valCursor = (ValueCursor) cmngr.createCursor();

String shortDescrForMemberVal = valCursor.getCurrentString();

if(firsttime)
{
    shortDescrForMemberVals.append(shortDescrForMemberVal);
    firsttime = false;
}
else
{
    shortDescrForMemberVals.append(", " + shortDescrForMemberVal);
}
}

return shortDescrForMemberVals;
}

/**
 * Inner class that implements the MetadataState object for this Template.
 * Stores data that can be changed by its SingleSelectionTemplate.
 * The data is used by a SingleSelectionTemplateGenerator in producing
 * a Source for the SingleSelectionTemplate.
 */
private static class SingleSelectionTemplateState
    implements MetadataState
{
    public Source measure;
    public ArrayList dimMemberInfos;

    /**
     * Creates a SingleSelectionTemplateState.
     */
    public SingleSelectionTemplateState(Source measure)
    {
        this(measure, new ArrayList());
    }

    private SingleSelectionTemplateState(Source measure,
                                         ArrayList dimMemberInfos)
    {
        this.measure = measure;
        this.dimMemberInfos = dimMemberInfos;
    }

    public Object clone()
    {
        return new SingleSelectionTemplateState(measure,
                                                (ArrayList)
                                                dimMemberInfos.clone());
    }
}
}
```

```
/**
 * Inner class that implements the SourceGenerator object for this Template.
 * Produces a Source based on the data values of a SingleSelectionTemplate.
 */
private static final class SingleSelectionTemplateGenerator
    implements SourceGenerator
{
    DataProvider dp = null;

    /**
     * Creates a SingleSelectionTemplateGenerator.
     */
    public SingleSelectionTemplateGenerator(DataProvider dataProvider)
    {
        dp = dataProvider;
    }

    /**
     * Generates a Source for the SingleSelectionTemplate.
     */
    public Source generateSource(MetadataState state)
    {
        SingleSelectionTemplateState castState =
            (SingleSelectionTemplateState) state;
        Source result = castState.measure;

        Iterator dimMemberInfosItr = castState.dimMemberInfos.iterator();
        while (dimMemberInfosItr.hasNext())
        {
            MdmDimensionMemberInfo mdmDimMemInfo = (MdmDimensionMemberInfo)
                dimMemberInfosItr.next();
            MdmHierarchy mdmHier = mdmDimMemInfo.getHierarchy();
            StringSource hierSrc = (StringSource) mdmHier.getSource();
            Source memberSel = hierSrc.selectValue(mdmDimMemInfo.getUniqueValue());
            // Join the Source objects for the selected dimension members
            // to the measure.
            result = result.joinHidden(memberSel);
        }
        return result;
    }
}
```

A

addCustomMember method, 2-12

aggregate data

- in a hierarchy, 5-6

aggregated values

- supplied by materialized views, 5-9

aggregating data

- for solved cubes, 5-8
- for unsolved cubes, 5-7

aggregation forms

- ET, 5-7
- for cubes, 5-7
- grouping set, 5-7
- rollup, 5-7

aggregation functions, 5-10

aggregation steps, 5-9

alias method

- description, 7-2
- example of, 7-2

analytic workspaces

- creating dynamic, 1-3

ancestors attribute

- example of getting, 4-7
- method for getting, 2-8

appendValues method

- example of, 7-3

application

- tasks performed by, 1-7

assigned values

- specified by an Assignment, 6-18

Assignment objects

- assigned value dependent on another Assignment, example of, 6-20
- assigned value result of aggregation, example of, 6-22
- of a Model, 6-17

asymmetric result set, Cursor positions in an, 9-14

at method, example of, 7-16

attributes

- based on a database column, 2-3, 2-10
- definition, 1-2
- example of getting, 4-7
- in OLAP metadata, 2-2
- MdmAttribute objects, 2-10

B

base cubes

- representing hierarchies, 5-3

base Source

- definition, 6-4, 7-1

Boolean OLAP API data type, 2-14

C

Catalog

- see* OLAP Catalog

class libraries, obtaining, A-1

classes12.jar file, 3-1, A-1

code for examples, 1-3

color custom MdmAttribute, 2-11, 6-22

COMPARISON_RULE_ASCENDING

- example of, 7-8, 7-17

COMPARISON_RULE_ASCENDING_NULLS_FIRST

- example of, 7-8

COMPARISON_RULE_ASCENDING_NULLS_LAST

- example of, 7-8

COMPARISON_RULE_DESCENDING

- example of, 7-6

COMPARISON_RULE_DESCENDING_NULLS_LAST

- example of, 7-8

COMPARISON_RULE_REMOVE

- example of, 6-8, 6-9, 7-5, 7-7, 7-20

COMPARISON_RULE_SELECT

- example of, 6-8, 6-9

CompoundCursor objects

- getting children of, example, 10-4
- navigating for a crosstab view, example, 10-9, 10-10
- navigating for a table view, example, 10-7
- positions of, 9-12

Connection objects

- example of closing, 3-4
- example of creating, 3-2
- example of getting an existing, 3-3

connections

- closing, 3-4
- getting existing, 3-3
- prerequisites, 3-1
- steps for establishing, 3-2

- count method, example of, 7-20
- createCustomMeasure method, 2-12
 - example of, 2-17
- createCustomMember method
 - example of, 2-12
- createListSource method
 - example of, 6-16, 7-11, 7-22, 7-23
- createParameterizedSource method, 6-15
 - example of, 6-16, 7-13, 7-24
- createRangeSource method, example of, 7-7
- createSQLCursorManager method, 9-1, 9-8
- createStandardCustomMember method, 2-12
- createTimeCustomMember method, 2-12
- crosstab view
 - example of, 7-3
 - navigating Cursor for, example, 10-9, 10-10
- cubes
 - aggregation forms for, 5-7
 - definition, 1-2
 - example of, 7-13
 - in OLAP metadata, 2-2, 2-3
 - partitioned into base cubes, 5-3
 - recording dimensionality of MdmMeasure objects, 5-3
 - solved, 5-7
 - unsolved, 5-7
- current position in a Cursor, definition, 9-11
- Cursor class
 - architecture, advantages of, 9-2
- Cursor objects
 - created in the current Transaction, 9-3
 - creating, example of, 7-13, 10-2
 - current position, definition, 9-11
 - CursorManager objects for creating, 9-8
 - extent calculation, example, 10-15
 - extent definition, 9-17
 - faster and slower varying components, 9-5
 - fetch size definition, 9-18
 - getting children of, example, 10-4
 - getting the values of, examples, 10-2
 - methods of creating, 9-1
 - parent starting and ending position, 9-15
 - position, 9-11
 - Source objects for which you cannot create, 9-3
 - span, definition, 9-15
 - specifying fetch size for a table view, example, 10-18
 - specifying the behavior of, 9-6, 10-14
 - starting and ending positions of a value, example of calculating, 10-16
 - structure, 9-4
- CursorInfoSpecification interface, 9-7
- CursorInput class, 9-6, 9-10
- CursorInput objects
 - compared to Parameter objects, 6-16
- CursorManager class, 9-8
- CursorManager objects
 - closing before rolling back a Transaction, 8-8
 - creating, example of, 7-13, 10-2

- methods of creating, 9-1
 - updating the CursorManagerSpecification, 9-9
- CursorManagerSpecification class, 9-6
 - creating object, example of, 7-13, 10-2
- CursorManagerUpdateEvent class, 9-10
- CursorManagerUpdateListener class, 9-10
- CursorSpecification class, 9-7
- CursorSpecification objects
 - getting from a CursorManagerSpecification, example, 10-14
- custom
 - MdmMeasure, creating, 2-17, 5-5
 - MdmMeasureDimension member, creating, 2-17
 - metadata objects, creating, 2-17
- custom dimension members
 - creating, 2-11, 2-12
 - new feature, xiii
- CustomModel class, 6-18
- CustomModel objects
 - example of, 6-19
 - inputs of, 6-18
 - outputs of, 6-18
 - parent Model objects of, 6-18

D

- data store
 - definition, 1-3
 - exploring, 4-2
 - gaining access to data in, 4-1
 - scope of, 4-1
- data type
 - of MDM metadata objects, 2-14
 - of Source objects, 6-3
 - OLAP API, 2-14
- data warehouse, 1-2
- DataProvider objects
 - creating, 3-3
 - needed to create MdmMetadataProvider, 4-3
- Date OLAP API data type, 2-14
- derived Source objects
 - definition, 6-2
- detailed data
 - in a hierarchy, 5-6
 - storage type, 5-9
- dimension members
 - creating custom, 2-11
- dimensioned Source, xiii
 - definition, 6-6
- dimensions
 - creating custom members, 2-11
 - definition, 1-1
 - dimensioning measures, 2-6
 - in OLAP metadata, 2-2
 - MdmDimension objects, 2-6
 - value formatting, 1-6
- distinct method
 - description, 7-2
 - example of, 7-3
- div method, example of, 7-19

DML
 custom dimension members not available to, 2-13
 Model object, 6-17, 6-18
Double OLAP API data type, 2-14
drilling in a hierarchy, example of, 7-16
DriverManager objects, 3-2
dynamic analytic workspaces, 1-3
dynamic queries, 11-1
dynamic Source objects
 definition, 6-2
 example of getting, 11-9
 produced by a Template, 11-1
DynamicDefinition class, 11-4

E

edges of a cube
 definition, 1-2
 pivoting, example of, 7-13
elements
 of a dimension, 2-2
 of an MdmAttribute, 2-11
 of an MdmMeasure, 2-9
embedded totals (ET) storage type, 5-9
Empty OLAP API data type, 2-15
empty Source objects
 definition, 6-2
ET aggregation form, 5-7
ETT tool, 1-2
example programs
 complete code for, 1-3
 new, xvii
 sample schema for, 1-3
ExpressDataCursorManager class, 9-8
ExpressDataCursorManager, returned by the
 createCursorManager method., 9-3
ExpressSpecifiedCursorManager class, 9-8
ExpressSpecifiedCursorManager, returned by the
 createCursorManager method., 9-3
ExpressSQLCursorManager class, 1-9, 9-1, 9-8
ExpressTransactionProvider class, 8-7
extent of a Cursor
 definition, 9-17
 example of calculating, 10-15
 use of, 9-18
extract method, 6-6
 description, 7-11
 example of, 6-16, 7-11, 7-22, 7-23
 implemented as a CustomModel, 6-19
extraction input
 definition, 6-7

F

faster varying Cursor components, 9-5
fetch size of a Cursor
 definition, 9-18
 example of specifying, 10-18
 reasons for specifying, 9-18
Float OLAP API data type, 2-14

font conventions
 OLAP API data types, 2-14
fundamental Source objects
 definition, 6-2
FundamentalMetadataObject class, 2-14
FundamentalMetadataProvider class, 2-14

G

generated SQL, getting, 9-1
getAncestorsAttribute method
 of an MdmHierarchy, 2-8
getDefaultMetadataProvider method
 example of, 4-3
getEmptySource method, 6-2
 example of, 6-8, 6-9, 6-12
getID method
 of a Source, 6-5
getID method, example of, 6-16
getInputs method, 6-7
getLevelAttribute method, example of, 7-7
getOutputs method
 of a Source, 6-7
getParentAttribute method
 of an MdmHierarchy, 2-8
getRootSchema method, 4-4
getSource method
 example of, 4-6, 7-7, 7-16
 for getting Source produced by a Template,
 example, 11-9
 in DynamicDefinition class, 11-1, 11-4
 of an MdmSource, 2-6
getSubSchema method, 4-5
getType method
 of a Source, 6-5
 of an MdmSource, example of, 2-17
getVoidSource method, 6-2
GID
 calculating values of, 5-9
 column of fact table, 5-9
Global Schema for Documentation with OLAP
 Catalog Metadata
 description, 1-3
 discovering metadata for, 4-7
Grouping ID (GID) column of fact table, 5-9
grouping set aggregation form, 5-7
Grouping Set, form of materialized view for
 aggregating data, 5-9
gt method, example of, 7-20

H

hierarchical sorting, example of, 7-17
hierarchies
 based on a database column, 2-3
 definition, 1-2
 in OLAP metadata, 2-2
 level-based, 5-6
 limit of levels in, 2-2, 5-6
 solved, 5-7

- unsolved, 5-7
- value-based, 5-7

hierarchies of an MdmDimension

- example of getting, 4-7

I

identification

- of a Source, 6-5

inputs

- of a Cursor, 9-10
- of a CustomModel, 6-18
- of a Model, 6-18
- of a Source
 - definition, 6-6
 - matching to a Source, 6-9, 6-10
 - obtaining, 6-7
 - producing, 6-6

Integer OLAP API data type, 2-14

interval method, example of, 7-24

isSubType method, example of, 6-5

J

Java archive (jar) files, required, 3-1

Java Development Kit, version required, A-1

JDBC

- Connection objects, 3-2
- DriverManager objects, 3-2
- libraries required, A-1
- loading drivers, 3-2

join method

- description, 7-2
- examples of, 7-2 to 7-25
- examples of using different comparison rules, 7-5
- rules governing matching a Source to an input, 6-10

L

lag method, example of, 7-22

leaf-level data

- in a hierarchy, 5-6
- storage type, 5-9

level hierarchy, 2-2, 5-6

levels

- based on a database column, 2-3
- definition, 1-2
- in OLAP metadata, 2-2
- limit of number in a hierarchy, 2-2, 5-6
- MdmLevel objects, 2-8

list Source objects

- definition, 6-2

local dimension value, 1-6

lowest level storage type, 5-9

M

mapping

- MdmSource objects to relational tables and expressions, 5-1

matching a Source to an input

- example, 6-11
- example of, 6-9, 6-12, 6-14
- rules governing, 6-10

materialized views

- solved cube as a, 5-7
- supplying aggregated values, 5-9

MDM. *See* multidimensional metadata model

MdmAttribute objects

- custom attribute, used in example, 6-22
- description, 2-10
- elements, 2-11

MdmAttributeModel class

- subclass of MdmDimensionedObject, 2-5

MdmAttributeModel objects

- not having parent Model objects, 6-18

MdmCustomObjectFactory object

- creating custom dimension members with, 2-12

MdmCustomObjectFactory objects

- creating custom metadata objects with, 2-17
- using to create a custom measure, 5-6

MdmDimension objects

- description, 2-6
- example of getting related objects, 4-6
- introduction, 1-5
- related MdmAttribute objects, 2-7

MdmDimensionCalculationModel class, 2-5

MdmDimensionCalculationModel objects

- not having parent Model objects, 6-18

MdmDimensionedObject class

- description, 2-9

MdmDimensionedObject object, 2-5

MdmDimensionedObjectModel class, 2-5

MdmHierarchy class, 2-7

MdmLevel objects

- description, 2-8
- members, 2-8

MdmLevelHierarchy objects

- description, 2-8

MdmMeasure objects

- creating custom, 2-11, 2-17, 5-5
- description, 2-9
- elements, 2-9
- example of getting their dimensions, 4-5
- introduction, 1-5
- kinds of values, 2-10

MdmMeasureModel

- subclass of MdmDimensionedObject, 2-5

MdmMeasureModel objects

- parent Model objects of, 6-18

MdmMember interface

- description, 2-11

MdmMetadataProvider objects

- creating, 4-3
- description, 4-2
- introduction, 1-5

MdmModel class, 2-5

MdmObject class, 2-3

MdmPrimaryDimension objects

- description, 2-7, 2-8

- MdmSchema objects
 - description, 2-5
 - getting contents of, 4-4
 - getting the root, 4-4
 - introduction, 1-5
 - root, 2-6, 4-3
- MdmSource objects, 2-6
- MdmStandardDimension objects
 - description, 2-7
- MdmSubDimension class, 2-7
- MdmTimeDimension objects
 - description, 2-7
- measure folders
 - in OLAP metadata, 2-2, 2-3
 - mapped to MdmSchema objects, 2-5
- measure MdmDimension objects, 4-5
- measures
 - based on a database column, 2-3, 2-9
 - definition, 1-2
 - dimensioned by dimensions, 1-2, 2-6
 - in OLAP metadata, 2-3
 - MdmMeasure objects, 2-9
- members
 - of a dimension, 2-2
 - of an MdmDimension, 2-6
 - of an MdmLevel, 2-8
- metadata
 - creating a provider, 4-3
 - definition, 1-2
 - discovering, 4-1
 - distinguished from data, 1-4
 - mapping OLAP metadata to MDM metadata, 2-4
 - preparation for OLAP API, 1-2, 2-2
 - sample code for discovering, 4-7 to 4-13
- metadata mapping (MTM) objects
 - definition, 5-1
- MetadataState class, 11-3
 - example of implementation, 11-8
- Model interface, 2-5, 6-18
 - description, 6-17
 - new feature, xiii
- movingTotal method, example of, 7-23
- MTM. *See* metadata mapping objects
- MtmAggregationSpecification class
 - description, 5-9
- MtmAggregationStep class
 - description, 5-9
- MtmAttributeMap objects
 - storing information about columns mapped to an MdmDimension, 5-2
- MtmBaseCube objects
 - description, 5-2
- MtmColumnExpression objects
 - mapping an MdmSource to a column, 5-3
- MtmCubeDimensionality objects
 - description, 5-2
- MtmCustomExpression objects
 - not mapped to a specific column, 5-3
- MtmDimensionMap objects
 - SQL statement for MdmSubDimension based on, 5-2
- MtmDimensionOrderSpecification objects
 - description, 5-2
- MtmExpression
 - mapping an MdmSource to a specific column, 5-3
- MtmExpression objects
 - creating with an MdmCustomObjectFactory, 5-6
 - description, 5-2
- MtmFirstLastAggregationStep class
 - description, 5-10
- MtmLiteralExpression objects
 - not mapped to a specific column, 5-3
- MtmMeasureMap objects
 - getting for an MdmMeasure, 5-6
 - SQL statement for MdmSubDimension based on, 5-2
- MtmNoAggregationStep class
 - description, 5-10
- MtmObject class
 - using to discover relational column mappings to MdmSource objects, 5-3
- MtmPartitionedCube objects
 - getting for an MtmMeasureMap, 5-6
- MtmSimpleAggregationStep class
 - description, 5-10
- MtmSolvedCubeDimensionality class
 - representing aggregation forms, 5-9
- MtmSolvedETCCubeDimensionality class
 - representing an aggregation form, 5-9
- MtmSolvedGroupingSetCubeDimensionality class
 - representing an aggregation form, 5-9
- MtmSolvedRollupCubeDimensionality class
 - representing an aggregation form, 5-9
- MtmSolveSpecification class
 - description, 5-9
- MtmSourceMap objects
 - mapping MdmSource to relational tables and expressions, 5-1
- MtmTabularSource objects
 - description, 5-2
- MtmWeightedAverageStep class
 - description, 5-10
- multidimensional metadata model (MDM)
 - description, 2-1
 - introduction, 1-5

N

- nested measure folders, 2-3
- nested outputs
 - getting values from a Cursor with, example, 10-5
 - of a Source, definition, 10-2
- null Source objects
 - definition, 6-2
- nullSource method, 6-2
- Number OLAP API data type, 2-14
- NumberParameter objects
 - example of, 7-24

O

OLAP API

- definition, 1-1
- required class libraries, A-1
- sample schema for examples, 1-3
- software components, 1-7

OLAP API data types

- font conventions, 2-14
- for MDM metadata objects, 2-14

OLAP Catalog, 1-2

OLAP metadata objects, 1-4, 2-2

olap_api.jar file, A-1

Oracle Enterprise Manager, 1-5

ORACLE_HOME environment variable, A-1

outputs

- getting from a CompoundCursor, example, 10-4
- getting from a CompoundCursorSpecification, example, 10-14
- getting nested, example, 10-5
- in a CompoundCursor, 9-4, 9-16, 9-17
 - positions of, 9-12
- of a CustomModel, 6-18
- of a Source
 - definition, 6-7
 - obtaining, 6-7
 - order of, 6-15, 7-3
 - producing, 6-8

P

Parameter objects

- compared to CursorInput objects, 6-16, 9-10
- description, 6-15
- example of, 6-16, 7-13, 7-24

parameterized Source objects

- definition, 6-2
- description, 6-15
- example of, 6-16, 7-13, 7-24

parent attribute

- example of getting, 4-7
- method for getting, 2-8

parent Model objects

- of a CustomModel, 6-18
- of a Model, 6-18

parent-child relationships

- in hierarchies, 2-2, 2-8
- in levels, 2-8

pivoting cube edges, example of, 7-13

placeholder Source

- new feature, xiv

placeholder Source objects

- definition, 6-3
- example of, 6-20, 6-22

plus method, example of, 7-20

position method, 6-6

- description, 7-2
- example of, 7-7

positions

- CompoundCursor, 9-12
- Cursor, 9-11

parent starting and ending, 9-15

ValueCursor, 9-11

precedence

- of an Assignment, 6-18

primary Source objects

- definition, 6-2
- from MdmSource objects, 2-6
- result of getSource method, 4-6

Q

Qualification objects

- of an Assignment, 6-17

queries

- creating using Source methods, 7-1
- definition, 1-2
- dynamic, 11-1
- Source objects that are not, 9-3
- specifying with Source objects, 6-1
- steps in retrieving results of, 10-1

R

range Source objects

- definition, 6-2

ranking values, 7-20

read Transaction object, 8-2

recursiveJoin method

- description, 7-2
- example of, 7-8, 7-17

regular input

- definition, 6-7

relational schema, 1-2, 1-5

Rolled Up, form of materialized view for aggregating data, 5-9

rollup aggregation form, 5-7

root MdmSchema

- description, 2-6
- function of, 4-3
- obtaining, 4-4

rotating cube edges, example of, 7-13

S

sample schemas, 1-3

schemas

- relationship to the OLAP API, 1-5
- star, 1-2

select method, example of, 7-20

SELECT statement

- for an MdmDimension, 5-2
- for an MdmMeasure, 5-2

selecting

- by position, 7-24
- by rank, 7-20
- by time series, 7-22

selectValue method

- example of, 7-3, 7-11

selectValues method

- example of, 7-10, 7-13

- setValue method
 - example of, 6-16, 7-13, 7-24
- Short OLAP API data type, 2-14
- SID (system identifier), 3-3
- SingleSelectionTemplate class, 8-5, 8-8, 11-9, B-1
- slower varying Cursor components, 9-5, 9-13
- solve specification, description, 5-9
- solved cubes, 5-7
 - aggregating data for, 5-8
- solved hierarchies, 5-7
- sorting hierarchically, example of, 7-17
- Source class
 - basic methods, 7-1
- Source objects
 - active in a Transaction object, 9-3
 - data type
 - definition, 6-3
 - getting, 6-3
 - dimensioned, xiii, 6-6
 - getting a modifiable Source from a
 - DynamicDefinition, 11-4
 - identification String
 - obtaining, 6-5
 - inputs of
 - definition, 6-6
 - matching to a Source, 6-9, 6-10
 - obtaining, 6-7
 - producing, 6-6
 - introducing, 6-1
 - kinds of, 6-2
 - methods of getting, 6-2
 - modifiable, 11-1
 - outputs of
 - definition, 6-7
 - obtaining, 6-7
 - producing, 6-8
 - parameterized, 6-15
 - SourceDefinition for, 6-6
 - specifying value of an Assignment, 6-18
 - subtype
 - definition, 6-5
 - obtaining, 6-5
 - type
 - definition, 6-4
 - obtaining, 6-5
- SourceDefinition, 6-6
- SourceGenerator class, 11-3
 - example of implementation, 11-8
- span of a value in a Cursor
 - definition, 9-15, 10-15
- SpecifiedCursorManager objects
 - closing, 9-9
 - creating, example of, 7-13
 - returned by the createCursorManager
 - method, 9-9
- SQL
 - custom dimension members not available to, 2-13
 - getting generated, 9-1
 - group functions, 5-10
 - Model clause, 6-17, 6-18

- SQLCursorManager class, 1-9
- star schema, 1-2
- String OLAP API data type, 2-14
- StringParameter objects
 - example of, 6-16, 7-13
- subschemas
 - description, 4-3
 - getting contents, 4-5
- subtype of an Source object
 - definition, 6-5
 - obtaining, 6-5

T

- table view
 - navigating Cursor for, example, 10-7
- Template class, 11-3
 - designing, 11-4
 - example of implementation, 11-5
- Template objects
 - classes used to create, 11-2
 - for creating modifiable Source objects, 11-1
 - relationship of classes producing a dynamic
 - Source, 11-3
 - Transaction objects used in, 8-3
- time series, selecting based on, 7-22
- times method, example of, 7-19
- TopBottomTemplate class, 8-5, 8-8, 11-5
- Transaction objects
 - child read and write, 8-2
 - committing, 8-2
 - creating a Cursor in the current, 9-3
 - current, 8-1
 - custom metadata objects existing in, 2-17
 - example of using child, 8-8
 - getting the current, 8-7
 - preparing, 8-2
 - read, 8-2
 - rolling back, 8-5
 - setting the current, 8-7
 - using in Template classes, 8-3
 - write, 8-2
- TransactionProvider interface, 8-7
- TransactionProvider objects
 - creating, 3-3
- tuple
 - definition, 2-10
 - in a Cursor, example, 10-6
 - specifying a measure value, 9-12
- type of an MDM object
 - definition, 2-16
 - obtaining, 2-17
- type of an Source object
 - definition, 6-4
 - obtaining, 6-5

U

- unique dimension value, 1-6

unsolved cubes, 5-7
 aggregating data for, 5-7
unsolved hierarchies, 5-7

V

value hierarchy, 2-2, 5-7
value method, 6-6
 description, 7-2
 example of, 7-10, 7-16, 7-20
Value OLAP API data type, 2-15
value separation string, 1-6
ValueCursor objects
 getting from a parent CompoundCursor,
 example, 10-4
 getting values from, example, 10-3
 position, 9-11
virtual Cursor
 definition, 9-18
Void OLAP API data type, 2-15
void Source objects
 definition, 6-2

W

write Transaction object, 8-2

X

xmlparserv2.jar file, A-1